

Series D7 Pilot Devices

<i>General Description</i>	H1:2
Pushbuttons	H1:4
<i>Non-Illuminated</i>	H1:4
<i>Illuminated</i>	H1:12
Push-Pull Devices	H1:20
<i>Three Position</i>	H1:24
Emergency Stop Operators	H2:2
<i>Non-Illuminated</i>	H2:2
<i>Keyed</i>	H2:4
Selector Switches	H3:2
<i>Non-illuminated</i>	H3:2
<i>Illuminated</i>	H3:8
<i>Keyed</i>	H3:12
Multi-function Pushbuttons	H4:2
<i>Build Your Own</i>	H4:4
Other Pilot Devices	
<i>Selector/Jog Operator</i>	H4:6
<i>Reset Operators</i>	H4:8
<i>Toggle Switches</i>	H4:9
<i>Potentiometer Operator</i>	H4:10
<i>Indicator Lights & Alarms</i>	H4:11
D7D Monolithic Devices	H5:2
Enclosures & Accessories	
<i>Pushbutton Stations</i>	H6:2
<i>E-Stop Pushbutton Stations</i>	H6:4
<i>Back of Panel & Components</i>	H6:5
<i>Legend Plates</i>	H6:11
<i>Specialty Contact & Power Module Kits</i>	H6:12
<i>Custom Printed Caps & Diffusers</i>	H6:14
<i>Custom Legend Plates</i>	H6:15
<i>Legend Plate Symbols & Texts</i>	H6:16
Technical Information	H7:1
<i>Dimensions</i>	H7:6



Series D7 Pilot Devices

The economical solution for high performance control, signaling and switching applications

Sprecher + Schuh's rugged D7 pilot devices offer maximum flexibility and a wide choice for all applications. This 22mm line is aesthetically appealing and modularly designed to make assembly and interchangeability easy. The D7 operators are available in two different body styles to meet every application need. Both operators exhibit a stylish, low profile appearance while maintaining the rugged performance necessary for demanding environments.

Two operator types

D7P is a plastic operator with a captive black plastic front bezel. Constructed of high-grade thermoplastics the D7P is the corrosion resistant solution for harsh environments.

For super tough applications, the D7M has a die-cast zinc housing and mounting ring for rugged durability. Both are finished with corrosion resistant chrome plating. The D7M also features a captive shiny metal bezel for a polished appearance.

Less inventory, more choices

Sprecher + Schuh offers D7 pushbuttons in a wide range of devices — from selector switches to multifunction pushbuttons. Their modular design keeps the number of required parts to a minimum, while offering multiple functions and a variety of style and color combinations.

Back-of-panel components can be combined with all front elements, making the D7 line extremely flexible. This approach reduces inventory, yet provides virtually any configuration you require.

Quick, easy installation

A standard anti-rotation tab keeps front elements from turning or falling off the control panel, making it possible for one person to install all D7 components even if the front and rear panel are not accessible at the same time. A central mounting ring allows for quick installation and removal of all D7 operators. All back-of-panel components, including



contact blocks and power module elements, snap-on and are readily accessible and interchangeable without removing the pilot device from the panel.

Tool-less mounting latch

The D7 “tool-less” mounting latch mates the front element with the contact blocks and other back-of-panel components. The mounting latch is available in a plastic and metal design. The latches are easily installed with a “click” and removed by pushing a rotating collar to the right. Quick, reliable and strong, it's the best pilot device mounting latch available in the industry.

Long electrical and mechanical life

Most D7 operators have a mechanical life of ten million operations... five million for contact blocks. Electrical life ranges from 500,000 cycles at 3A to ten million at 0.1A. The D7 line is also electronics compatible with self-cleaning contacts.



Environmental ratings

Front elements, including pushbuttons, mushroom operators and selector switches, are IP 66 protection against submersion, oil and dirt, making them reliable in the toughest industrial environments. Metal operators are Type 4/13 and plastic operators are Type 4/4X/13.

H1

D7 Pilot Devices



D7P – Plastic housing with a black plastic captive bezel.



D7M – Die-cast metal housing and locking ring with shiny metal captive bezel.

D7 Pilot Devices –Modular, flexible and complete

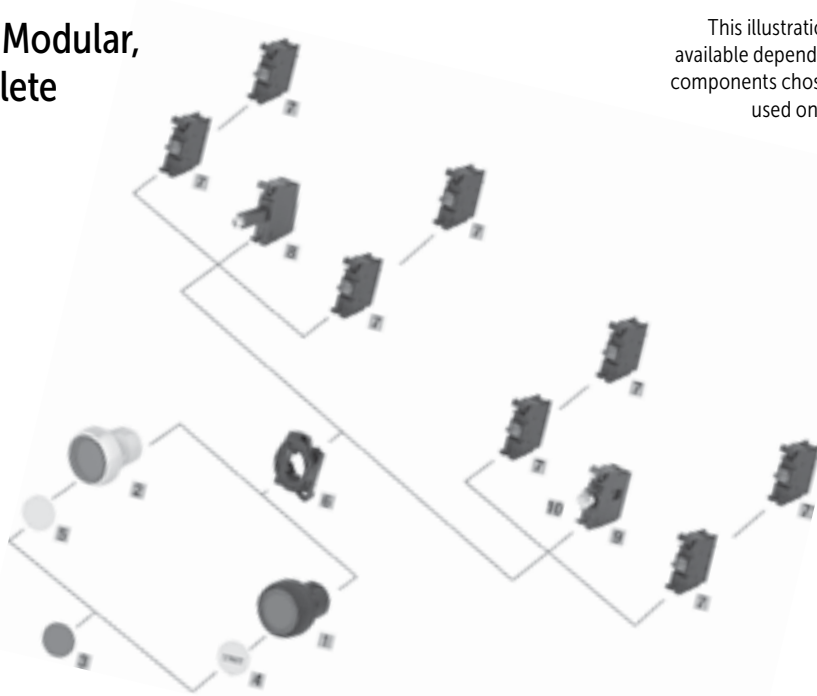

This illustration shows typical combinations available depending on the front and back-of-panel components chosen. Up to six contact blocks can be used on non-illuminated devices.

- | | | |
|---|---|---|
| <p>1 D7P Operator – Corrosion resistant plastic construction with black plastic bezel</p> <p>2 D7M Operator – Metal construction with shiny metal bezel</p> <p>3 Colored Lenses and Color Caps – Available in many colors</p> | <p>4/5 Inscription Diffusers – Diffusers and color caps available in many standard text and ISO symbol options, and foreign languages</p> <p>6 Tool-less Mounting Latch – For snap-on contact blocks and power module elements</p> <p>7 Contact Blocks – Five types available including NOEM, NCLB, and Low Voltage</p> | <p>8 Power Modules, Integral LED – Full voltage module requires only one slot</p> <p>9 Power Modules, Incandescent – Full voltage module requires only one slot</p> <p>10 Bulbs – Incandescent bulbs that include the incandescent power module</p> |
|---|---|---|

Additional features and options

Heavy-Duty Ratings – The D7 line is UL 46E, NEMA A600 and Q600 listed. All components carry a 10 Amp continuous current rating, covering all industrial control needs.

All Major Approvals – D7 front elements are UL Recognized, while all D7 assemblies are UL Approved. The line is also approved by every major international agency making them ideal for export requirements.

Special Contact Blocks & Power Modules – Screwless terminals are available for latching integral LED modules.

H-Bridge & Gold Plated Contacts – By doubling the available paths for current to pass through the contacts, the standard H-bridge design provides a cleaner current flow. Gold plated contacts quadruple the current paths for increased contact reliability in low voltage applications.

Molded Inscription Caps/Diffusers – Abrasion proof inscription caps/diffusers are offered in a two-color molded design for most common inscription text and symbols used in the industry.

Custom Printed Caps/Diffusers – Durable long lasting custom printed inscription caps/diffusers are offered in a wide variety of ISO symbols and text options, and withstand repeated use in the harshest environments.

Touch-Safe – Back of panel components are finger safe, with IP 20 protection.

Long Lasting Integral LED Assemblies – Our LED lamps last up to 11 years! They are conveniently offered as a complete unit for all illuminated operators which include the one-piece Integral LED Module. They come in three different colors: green, red and white.





Full Line of Accessories and Enclosures – A variety of metal and plastic enclosures are available for any application. Replacement components, legend plates and convenient accessories are available from stock, including rings for adapting 30mm holes to fit the 22mm D7 line.

H1

D7 Pilot Devices

Standard Pushbuttons, Flush, Non-Illuminated, Momentary (Complete Kits) ①

	Plastic operator with plastic bezel ④⑤	Metal operator with metal bezel ④⑤
Contact Block(s) ②③		
	Catalog Number	Catalog Number
Oper. Only	D7P-F ⬆️	D7M-F ⬆️
1NO	D7P-F ⬆️PX10	D7M-F ⬆️PX10
1NC	D7P-F ⬆️PX01	D7M-F ⬆️PX01
2NO	D7P-F ⬆️PX20	D7M-F ⬆️PX20
2NC	D7P-F ⬆️PX02	D7M-F ⬆️PX02
1NO/1NC	D7P-F ⬆️PX11	D7M-F ⬆️PX11
3NO	D7P-F ⬆️PX30	D7M-F ⬆️PX30
3NC	D7P-F ⬆️PX03	D7M-F ⬆️PX03
2NO/1NC	D7P-F ⬆️PX21	D7M-F ⬆️PX21
1NO/2NC	D7P-F ⬆️PX12	D7M-F ⬆️PX12

Complete Kit Ordering Instructions

H1

D7 Pilot Devices

D7P –	F	★	▼	P	X10
Oper. Construction D7P - Plastic operator with plastic bezel (Type 4/4X/13, IP66) D7M - Metal operator with metal bezel (Type 4/13, IP66)	Operator Type F - Flush, momentary, non-illuminated See Footnote ④ G - Guarded operator, momentary, non-illuminated 	Color Cap 0 - Orange 1 - White 2 - Black 3 - Green 4 - Red 5 - Yellow 6 - Blue 8 - Gray 9 - No Cap	Inscription ①⑤⑥ <i>Omit this position for a blank color cap</i> Standard Molded Caps 01 - START 02 - STOP 04 - Red 06 - I 08 - → ⑦ 09 - FORWARD 10 - REVERSE 11 - R Custom Printed caps sold separately. See note ⑥.	Mounting Latch P - Plastic latch (D7P and D7M offered with plastic latch as standard) M - Metal latch List price changes	Contacts ②③ X10 - 1NO X01 - 1NC → X20 - 2NO X02 - 2NC X11 - 1NO/1NC X30 - 3NO X03 - 3NC X21 - 2NO/1NC X12 - 1NO/2NC

→ Positive Opening per EN60947-5-1 (applies to all NC contact block styles)

Standard Molded Inscription Caps ⑤

Molded Cap Selection Table ⑦⑧	
Color	Text Flush Caps
White	START, I, →, R, FORWARD, REVERSE
Black	→, R, FORWARD, REVERSE
Green	START, I, →, FORWARD, REVERSE
Red	STOP, O, →, FORWARD, REVERSE
Yellow	→, FORWARD, REVERSE
Blue	→, R, FORWARD, REVERSE

- ① Legend plates provided separately. See page H6:11 for information.
- ② Up to 6 contact blocks (3 across / 2 high) can be attached.
- ③ See page H6:12 for complete kit ordering information on other special contact blocks: Early make, late break, low voltage, and contact blocks.
- ④ For guarded operator, substitute "G" for "F" in catalog number. Example: Change D7P-F⬆️ to D7P-G⬆️. List price changes.

- ⑤ One blank color cap included. For standard molded inscriptions List price changes.
- ⑥ Custom printed caps sold separately, see page H6:14. Order kits with "No Cap" and order the custom printed caps separately for customer installation.
- ⑦ Rotation every 90° (→, ←, ↓, ↑). All legend caps supplied loose for customer installation.
- ⑧ Valid color cap/legend text codes. White and yellow caps have black text. All other caps have white text.

Standard Pushbuttons, Flush, Non-Illuminated, Momentary (Components) ❶

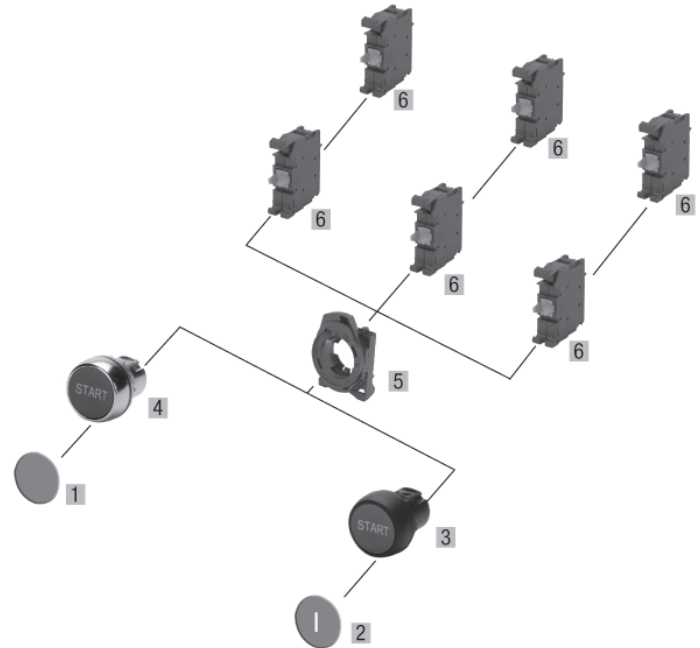

Component		Catalog Number	Pkg. Qty.
01	Color caps momentary flush/guarded	Orange D7-AF0 White D7-AF1 Black D7-AF2 Green D7-AF3 Red D7-AF4 Yellow D7-AF5 Blue D7-AF6 Grey D7-AF8	10
02	Inscription color caps momentary ❶❷❸	Green START D7-AF301 Green I D7-AF306 Green → D7-AF308 Red STOP D7-AF402 Red O D7-AF405 Red → D7-AF408 White START D7-AF101 White I D7-AF106 White → D7-AF108 White R D7-AF111 Blue → D7-AF608 Blue R D7-AF611 Black → D7-AF208 Black R D7-AF211 Black FORWARD D7-AF209 White FORWARD D7-AF109 White REVERSE D7-AF110 Green FORWARD D7-AF309 Green REVERSE D7-AF310 Red FORWARD D7-AF409 Red REVERSE D7-AF410 Yellow FORWARD D7-AF509 Yellow REVERSE D7-AF510 Blue FORWARD D7-AF609 Blue REVERSE D7-AF610 Black REVERSE D7-AF210 Yellow → D7-AF508	10
	<i>Molded</i>		
	<i>Custom printed</i>	Green ON D7-AF3CE166 Red OFF D7-AF4CE165 Black AUTO D7-AF2CE101 Black CLOSE D7-AF2CE107 Black DOWN D7-AF2CE110 Black FAST D7-AF2CE114 Black HAND D7-AF2CE126 Black LEFT D7-AF2CE145 Black LOWER D7-AF2CE152 Black RAISE D7-AF2CE182 Black RIGHT D7-AF2CE191 Black RUN D7-AF2CE193 Black SETUP D7-AF2CE198 Black SLOW D7-AF2CE201 Black UP D7-AF2CE223	1



Component	Catalog Number	Pkg. Qty.
03 Plastic operator with plastic bezel, momentary flush ❹	D7P-F9	1
04 Metal operator with shiny metal front bezel momentary, flush ❹	D7M-F9	1
05 Tool-less Mounting Latch (for snap-on contact blocks and power modules)		
Plastic Latch	D7-ALP	10
Metal Latch	D7-ALM	
06 Contact blocks ❺		
NO	D7-X10	10
NC	D7-X01	
NO, low voltage	D7-X10V ❻	
NC, low voltage	D7-X01V ❻	

- ❶ Legend plates provided separately. See page H6.11 for information.
- ❷ See page H6.14 for other custom printed ISO and text options.
- ❸ Rotation every 90° (→ ← ↻ ↻)
- ❹ For guarded operator, substitute "G" for "F" in catalog number. For example change D7P-F9 to D7P-G9. List price changes.
- ❺ Up to 6 contact blocks (3 across / 2 high) can be attached.
- ❻ Low voltage contact blocks must be ordered separately.

Standard Pushbuttons, Flush, Non-Illuminated, Maintained (Complete Kits) ①

Contact Block(s) ②③	Plastic operator with plastic bezel ④	Metal operator with metal bezel ④
		
	Catalog Number	Catalog Number
Oper. Only	D7P-FA	D7M-FA
1NOEM	D7P-FA [⊕] PX10E	D7M-FA [⊕] PX10E
1NC	D7P-FA [⊕] PX01	D7M-FA [⊕] PX01
2NOEM	D7P-FA [⊕] PX20E	D7M-FA [⊕] PX20E
2NC	D7P-FA [⊕] PX02	D7M-FA [⊕] PX02
1NOEM/1NC	D7P-FA [⊕] PX11E	D7M-FA [⊕] PX11E
3NOEM	D7P-FA [⊕] PX30E	D7M-FA [⊕] PX30E
3NC	D7P-FA [⊕] PX03	D7M-FA [⊕] PX03
2NOEM/1NC	D7P-FA [⊕] PX21E	D7M-FA [⊕] PX21E
1NOEM/2NC	D7P-FA [⊕] PX12E	D7M-FA [⊕] PX12E

Important Note:
Maintained D7x-FA operators must use NOEM or NC contact blocks only.

Complete Kit Ordering Instructions

D7P –	FA	★	P	X10E
Oper. Construction D7P - Plastic operator with plastic bezel (Type 4/4X/13, IP66) D7M - Metal operator with metal bezel (Type 4/13, IP66)	Operator Type FA - maintained, non-illuminated	Color Cap 0 - Orange 1 - White 2 - Black 3 - Green 4 - Red 5 - Yellow 6 - Blue 9 - No Cap <i>Custom printed caps sold separately. See note ④</i>	Mounting Latch P - Plastic latch (D7P and D7M offered with plastic latch as standard) M - Metal latch <i>List price changes</i>	Contacts ②③ X10E - 1NOEM X20E - 2NOEM X11E - 1NOEM/1NC X30E - 3NOEM X21E - 2NOEM/1NC X12E - 1NOEM/2NC X01 - 1NC → X02 - 2NC → X03 - 1NC

→ Positive Opening per EN60947-5-1 (applies to all NC contact block styles)

- ① Legend plates sold separately. See page H6:11 for information.
- ② Up to 6 contact blocks (3 across / 2 high) can be attached.
- ③ See page H6:12 for complete kit ordering information on other special contact blocks.
- ④ Custom printed caps sold separately, see page H6:14. Order kits with "No Cap" and order the custom printed caps separately for customer installation.

Standard Pushbuttons, Flush, Non-Illuminated, Maintained (Components) ❶

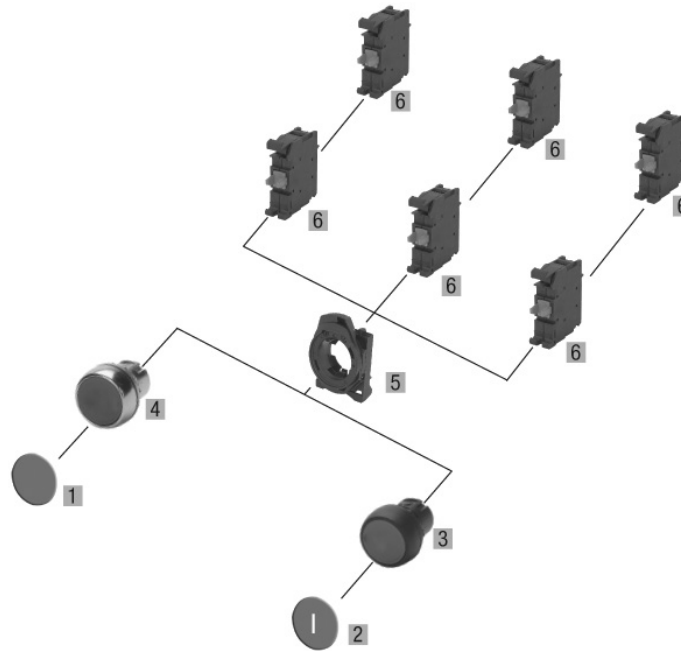



Component	Catalog Number	Pkg. Qty.
01 Color caps maintained, flush Orange White Black Green Red Yellow Blue	D7-AFA0 D7-AFA1 D7-AFA2 D7-AFA3 D7-AFA4 D7-AFA5 D7-AFA6	10
02 Custom printed color caps maintained ❶❷❸ Green ON Red OFF Black AUTO Black CLOSE Black DOWN Black FAST Black HAND Black LEFT Black LOWER Black RAISE Black RIGHT Black RUN Black SETUP Black SLOW Black UP	D7-AFA3CE166 D7-AFA4CE163 D7-AFA2CE101 D7-AFA2CE107 D7-AFA2CE110 D7-AFA2CE114 D7-AFA2CE126 D7-AFA2CE145 D7-AFA2CE152 D7-AFA2CE182 D7-AFA2CE191 D7-AFA2CE193 D7-AFA2CE198 D7-AFA2CE201 D7-AFA2CE223	1
03 Plastic operator with plastic bezel, maintained, flush	D7P-FA9	1
04 Metal operator with shiny metal front bezel maintained, flush	D7M-FA9	1
05 Tool-less Mounting Latch (for snap-on contact blocks and power modules) Plastic Latch Metal Latch	D7-ALP D7-ALM	10

Component	Catalog Number	Pkg. Qty.
06 Contact blocks ❹❺ NC NO, early make NC, low voltage	D7-X01 D7-X10E D7-X01V	10

- ❶ Legend plates sold separately. See page H6:11 for information.
- ❷ See page H6:14 for other custom printed ISO and text options.
- ❸ Rotation every 90° (→, ←, ↓, ↑)
- ❹ Up to 6 contact blocks (3 across / 2 high) can be attached.
- ❺ Maintained D7x-FA operators must use NOEM or NC contact blocks only.

Standard Pushbuttons, Extended, Momentary, Non-Illuminated (Complete Kits) ①

Contact Block(s) ②③	Plastic operator with plastic bezel	Metal operator with metal bezel
		
	Momentary ④	Momentary ④
	Catalog Number	Catalog Number
Oper. Only	D7P-E ▼	D7M-E ▼
1NO	D7P-E ▼PX10	D7M-E ▼PX10
1NC	D7P-E ▼PX01	D7M-E ▼PX01
2NO	D7P-E ▼PX20	D7M-E ▼PX20
2NC	D7P-E ▼PX02	D7M-E ▼PX02
1NO/1NC	D7P-E ▼PX11	D7M-E ▼PX11
3NO	D7P-E ▼PX30	D7M-E ▼PX30
3NC	D7P-E ▼PX03	D7M-E ▼PX03
2NO/1NC	D7P-E ▼PX21	D7M-E ▼PX21
1NO/2NC	D7P-E ▼PX12	D7M-E ▼PX12

Complete Kit Ordering Instructions

D7P –	E	★	▼	P	X10
Oper. Construction D7P - Plastic operator with plastic bezel (Type 4/4X/13, IP66) D7M - Metal operator with metal bezel (Type 4/13, IP66)	Operator Type E - Extended, momentary, non-illuminated	Color Cap 0 - Orange 1 - White 2 - Black 3 - Green 4 - Red 5 - Yellow 6 - Blue 9 - No Cap	Inscription ①④⑤ <i>Omit this position for a blank color cap</i> Standard Molded Caps 02 - STOP 05 - O 08 - → 11 - R Custom printed caps sold separately, see note ⑤	Mounting Latch P - Plastic latch (D7P and D7M offered with plastic latch as standard) M - Metal latch List price changes	Contacts ②③ X10 - 1NO X01 - 1NC → X20 - 2NO X02 - 2NC X11 - 1NO/1NC X30 - 3NO X03 - 3NC X21 - 2NO/1NC X12 - 1NO/2NC

→ Positive Opening per EN60947-5-1 (applies to all NC contact block styles)

Standard Molded Inscription Caps ⑤

Color	Text Extended Caps
White	→, R
Black	STOP, O, →, R
Green	→
Red	STOP, O, →
Yellow	→
Blue	→, R

NEC CODE TIP:

The D7P-E...and D7M-E...meets NFPA-79, 10.2.1 which states pushbutton actuators used to initiate a stop function shall be of the extended operator or mushroom-head type.

① Legend plates sold separately. See page H6:11 for information.

② Up to 6 contact blocks (3 across / 2 high) can be attached.

③ See page H6:12 for complete kit ordering information on other special contact blocks: Early make, late break, low voltage contact blocks.

④ One blank color cap included. All legend caps supplied loose for customer installation. For standard molded inscription caps, List price changes..

⑤ Custom printed caps sold separately, see page H6:14. Order kits with "No Cap" and order the custom printed caps separately for customer installation.

⑥ Valid color cap/legend text codes. White and yellow caps have black text. All other caps have white text.

Standard Pushbuttons, Extended, Momentary, Non-Illuminated (Components) ❶

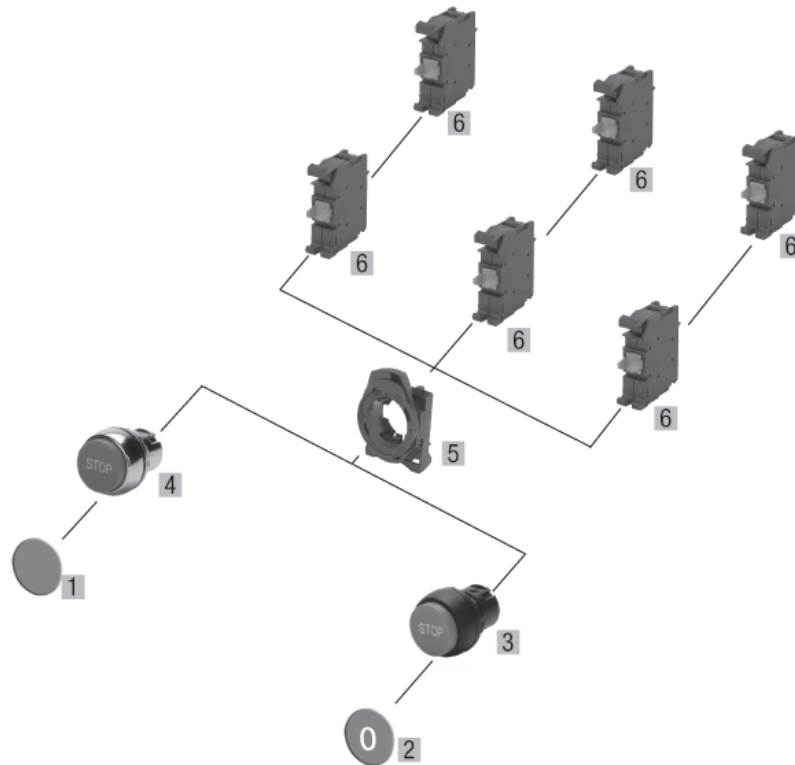



Component		Catalog Number	Pkg. Qty.
01 Color caps	Orange	D7-AE0	10
	White	D7-AE1	
	Black	D7-AE2	
	Green	D7-AE3	
	Red	D7-AE4	
	Blue	D7-AE6	
02 Inscription color caps ❶❷	Green →	D7-AE308	10
	Red STOP	D7-AE402	
	Red O	D7-AE405	
	Red →	D7-AE408	
	White →	D7-AE108	
	White R	D7-AE111	
	Blue →	D7-AE608	
	Blue R	D7-AE611	
	Black STOP	D7-AE202	
	Black O	D7-AE205	
	Black →	D7-AE208	
	Black R	D7-AE211	
	Black →	D7-AE508	
	Yellow →		

Component		Catalog Number	Pkg. Qty.
03	Plastic operator with plastic bezel, momentary, extended	D7P-E9	1
04	Metal operator with shiny metal bezel, momentary, extended	D7M-E9	1
05	Tool-less Mounting Latch (for snap-on contact blocks and power module)	Plastic Latch	10
		Metal Latch	
06	Contact blocks ❸	NO	10
		NC	
		NO, low voltage	
		NC, low voltage	
		D7-X10	
		D7-X01	
		D7-X10V ❹	
		D7-X01V ❹	

❶ Legend plates sold separately. See page H6:11 for information.
 ❷ See page H6:14 for other custom printed ISO and text options.
 ❸ Up to 6 contact blocks (3 across / 2 high) can be attached.
 ❹ Low voltage contact blocks must be ordered separately.

Standard Pushbuttons, Mushroom, Momentary, Non-Illuminated (Complete Kits) ③

Contact Block(s) ①②	Plastic operator with plastic bezel		Metal operator with metal bezel	
				
	40mm Mushroom ③	60mm Mushroom ③	40mm Mushroom ③	60mm Mushroom ③
	Catalog Number	Catalog Number	Catalog Number	Catalog Number
Oper. Only	D7P-MM4 ④	D7P-MM6 ④	D7M-MM4 ④	D7M-MM6 ④
1NO	D7P-MM4 ④PX10	D7P-MM6 ④PX10	D7M-MM4 ④PX10	D7M-MM6 ④PX10
1NC	D7P-MM4 ④PX01	D7P-MM6 ④PX01	D7M-MM4 ④PX01	D7M-MM6 ④PX01
2NO	D7P-MM4 ④PX20	D7P-MM6 ④PX20	D7M-MM4 ④PX20	D7M-MM6 ④PX20
2NC	D7P-MM4 ④PX02	D7P-MM6 ④PX02	D7M-MM4 ④PX02	D7M-MM6 ④PX02
1NO/1NC	D7P-MM4 ④PX11	D7P-MM6 ④PX11	D7M-MM4 ④PX11	D7M-MM6 ④PX11
3NO	D7P-MM4 ④PX30	D7P-MM6 ④PX30	D7M-MM4 ④PX30	D7M-MM6 ④PX30
3NC	D7P-MM4 ④PX03	D7P-MM6 ④PX03	D7M-MM4 ④PX03	D7M-MM6 ④PX03
2NO/1NC	D7P-MM4 ④PX21	D7P-MM6 ④PX21	D7M-MM4 ④PX21	D7M-MM6 ④PX21
1NO/2NC	D7P-MM4 ④PX12	D7P-MM6 ④PX12	D7M-MM4 ④PX12	D7M-MM6 ④PX12

Complete Kit Ordering Instructions

D7P –	MM4	★	P	X10
Oper. Construction	Operator Type	Color Cap ③	Mounting Latch	Contacts ①②
D7P - Plastic operator with plastic bezel (Type 4/4X/13, IP65)	MM4 - Mushroom, 40mm, momentary, non-illuminated	2 - Black 3 - Green 4 - Red 5 - Yellow 6 - Blue	P - Plastic latch <i>(D7P and D7M offered with plastic latch as standard)</i>	X10 - 1NO X01 - 1NC → X20 - 2NO X02 - 2NC X11 - 1NO/1NC X30 - 3NO X03 - 3NC X21 - 2NO/1NC X12 - 1NO/2NC
D7M - Metal operator with metal bezel (Type 4/13, IP65)	MM6 - Mushroom, 60mm, momentary, non-illuminated		Metal latch M - List price changes	

→ Positive Opening per EN60947-5-1 (applies to all NC contact block styles)

- ① Up to 6 contact blocks (3 across / 2 high) can be attached.
- ② See page H6.12 for complete kit ordering information on other special contact blocks: Early make, late break, low voltage, contact blocks.
- ③ Not available with inscriptions. Order inscription ring or legend plate for identification. See pages H6.6 and H6.11 for information.

Standard Pushbuttons, Mushroom, Momentary, Non-Illuminated (Components) ❶

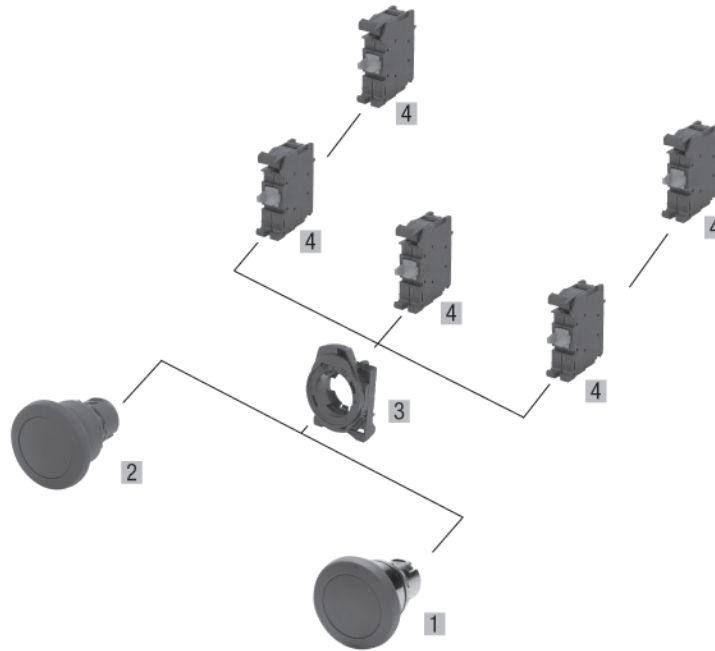

Component	Catalog Number	Pkg. Qty.
01 Plastic operator with plastic bezel, momentary, 40mm mushroom ❶ Black Green Red Yellow Blue Plastic operator with plastic bezel, momentary, 60mm mushroom ❶ Black Green Red Yellow Blue	D7P-MM42	1
	D7P-MM43	
	D7P-MM44	
	D7P-MM45	
	D7P-MM46	
	D7P-MM62	1
	D7P-MM63	
	D7P-MM64	
	D7P-MM65	
	D7P-MM66	
02 Metal operator with metal bezel, momentary, 40mm mushroom ❶ Black Green Red Yellow Blue Metal operator with metal bezel, momentary, 60mm mushroom ❶ Black Green Red Yellow Blue	D7M-MM42	1
	D7M-MM43	
	D7M-MM44	
	D7M-MM45	
	D7M-MM46	
	D7M-MM62	1
	D7M-MM63	
	D7M-MM64	
	D7M-MM65	
	D7M-MM66	

Component	Catalog Number	Pkg. Qty.
03 Tool-less Mounting Latch (for snap-on contact blocks and power modules) Plastic Latch Metal Latch	D7-ALP	10
	D7-ALM	
04 Contact blocks ❷ NO NC NO, low voltage NC, low voltage	D7-X10 D7-X01	10
	D7-X10V ❸ D7-X01V ❸	

❶ Not available with inscriptions. Order inscription ring or legend plate for identification. See pages H6:6 and H6:11 for ordering information.

❷ Up to 6 contact blocks (3 across / 2 high) can be attached.

❸ Low voltage contact blocks must be ordered separately.

Standard Pushbuttons, Flush, Illuminated, Momentary (Complete Kits) ①

Contact Block(s) ③④	Plastic operator with plastic bezel	Metal operator with metal bezel
		
	Momentary ②⑤	Momentary ②⑤
Catalog Number		Catalog Number
Oper. Only	D7P-LF③	D7M-LF③
Incandescent Module (Bulb Included)		
1NO	D7P-LF③P♣X10	D7M-LF③P♣X10
1NC	D7P-LF③P♣X01	D7M-LF③P♣X01
2NO	D7P-LF③P♣X20	D7M-LF③P♣X20
2NC	D7P-LF③P♣X02	D7M-LF③P♣X02
1NO/1NC	D7P-LF③P♣X11	D7M-LF③P♣X11
Integral LED Module		
1NO	D7P-LF③P♣X10	D7M-LF③P♣X10
1NC	D7P-LF③P♣X01	D7M-LF③P♣X01
2NO	D7P-LF③P♣X20	D7M-LF③P♣X20
2NC	D7P-LF③P♣X02	D7M-LF③P♣X02
1NO/1NC	D7P-LF③P♣X11	D7M-LF③P♣X11

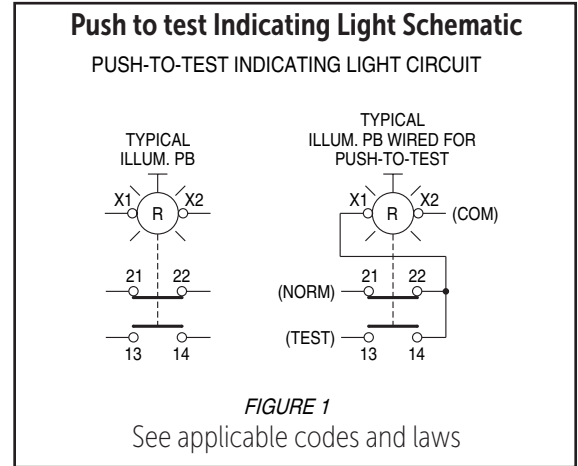

Complete Kit Ordering Instructions

D7P	–	LF	★	P	♣	X10
Oper. Construction		Operator Type	Lens Color	Mounting Latch	Power Module	Contacts ③④
D7P - Plastic operator with plastic bezel (Type 4/4X/13, IP66)		LF - Flush, momentary, illuminated	0 - Amber 3 - Green 4 - Red 5 - Yellow 6 - Blue 7 - Clear 9 - No lens	P - Plastic latch (D7P and D7M offered with plastic latch as standard)	Incandescent module D0 - no bulb D1 - 6V, bulb D2 - 12V, bulb D3 - 24V, bulb D4 - 48V, bulb D5 - 120V, bulb	X10 - 1NO X01 - 1NC X20 - 2NO X02 - 2NC X11 - 1NO/1NC
D7M - Metal operator with metal bezel (Type 4/13, IP66)		See Footnote ② LG - Guarded operator, momentary, illuminated	Custom printed diffusers sold separately, see Note 5.	M - Metal latch List price changes	Integral LED module N3x, 24V AC/DC N5x, 120V AC N7x, 240V AC	

LED Module Code Selection	
For lens color...	replace "x" with...
Green	G
Red	R
Amber Yellow Blue Clear	W

➡ Positive Opening per EN60947-5-1 (applies to all NC contact block styles)

① Legend plates sold separately. See page H6:11 for information.

② For guarded operator, substitute "G" for "F" in catalog number. For example change D7P-LF③ to D7P-LG③. List price changes.

③ Up to 4 contact blocks can be attached.

④ See page H6:12 for complete kit ordering information on other special contact blocks and power modules.

⑤ One blank inscription diffuser included. For custom printed diffuser, order operator with applicable lens cap color plus custom printed diffuser on page H6:14, sold separately.

Standard Pushbuttons, Flush, Illuminated, Momentary (Components) ❶

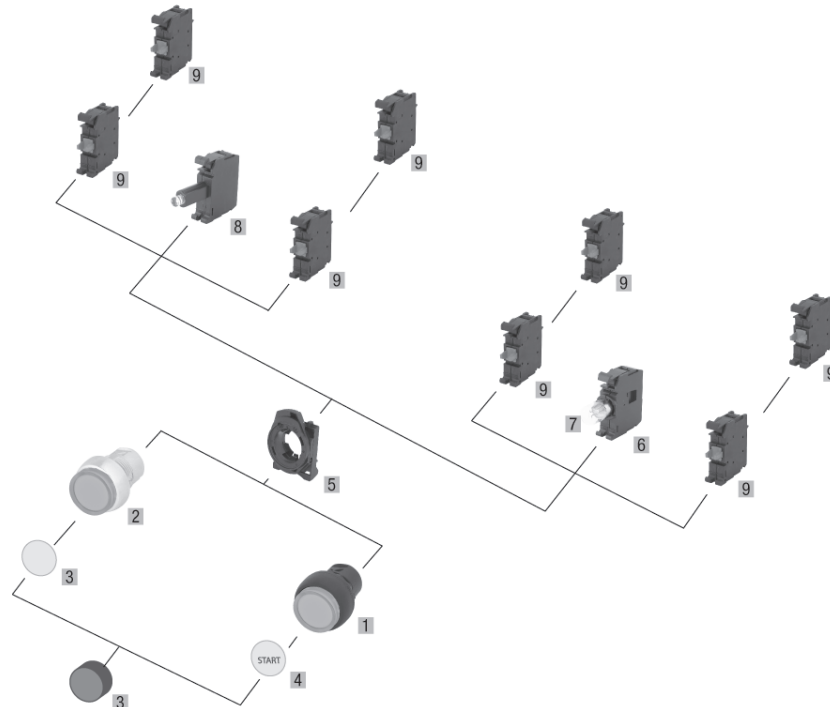

Component	Catalog Number	Pkg. Qty.
01 Illuminated plastic operator with plastic bezel, momentary, flush ❷	D7P-LF9	1
02 Illuminated metal operator with shiny metal bezel, momentary, flush ❷	D7M-LF9	1
03 Lens Cap (includes diffuser)	Amber Green Red Yellow Blue Clear D7-ALF0 D7-ALF3 D7-ALF4 D7-ALF5 D7-ALF6 D7-ALF7	10
04 Custom printed Inscription diffusers ❶❷	AUTO CLOSE DOWN FAULT FAST FORWARD HAND HIGH LOW OFF ON OPEN REVERSE RUN SLOW START STOP UP D7-AD2CE101 D7-AD2CE107 D7-AD2CE110 D7-AD2CE113 D7-AD2CE114 D7-AD2CE120 D7-AD2CE126 D7-AD2CE129 D7-AD2CE148 D7-AD2CE163 D7-AD2CE166 D7-AD2CE170 D7-AD2CE188 D7-AD2CE193 D7-AD2CE201 D7-AD2CE208 D7-AD2CE212 D7-AD2CE223	1

Component	Catalog Number	Pkg. Qty.
05 Tool-less Mounting Latch (for snap-on contact blocks and power modules)	Plastic Latch Metal Latch D7-ALP D7-ALM	10
06 Power Module, Incandescent	D7-D0C	10
07 Lamps, Incandescent	6V AC/DC 12V AC/DC 24V AC/DC 48V AC/DC 130V AC/DC D7-N65 D7-N141 D7-N157 D7-N48 D7-N130	10
08 Power Module, Integral LED ❸	24V AC/DC 120V AC 240V AC D7-N3x D7-N5x D7-N7x	10
09 Contact blocks ❹	NO NC NO, low voltage NC, low voltage D7-X10 D7-X01 D7-X10V ❷ D7-X01V ❷	10

❶ Legend plates sold separately. See page H6.11 for order information.

❷ For guarded operator, substitute "G" for "F" in catalog number. For example change D7P-LF9 to D7P-LG9. List price changes.



❸ Up to 4 contact blocks can be attached.

❹ See page H6.14 for other custom printed ISO and text options.

❺ To complete the catalog no., replace the "x" with one of the codes on the

❻ Low voltage contact blocks must be ordered separately. previous page.

Standard Pushbuttons, Flush, Illuminated, Maintained (Complete Kits) ①⑤

Contact Block(s) ②③	Plastic operator with plastic bezel	Metal operator with metal bezel
		
	Maintained ④	Maintained ④
	Catalog Number	Catalog Number
Oper. Only	D7P-LFA④	D7M-LFA④
Integral LED Module		
1NOEM	D7P-LFA④P♣X10E	D7M-LFA④P♣X10E
1NC	D7P-LFA④P♣X01	D7M-LFA④P♣X01
2NOEM	D7P-LFA④P♣X20E	D7M-LFA④P♣X20E
2NC	D7P-LFA④P♣X02	D7M-LFA④P♣X02
1NOEM/1NC	D7P-LFA④P♣X11E	D7M-LFA④P♣X11E

Important Note for maintained operators:

- D7x-LFA operator must be used with NOEM or NC contacts only.
- LED module required for illumination, cannot use incandescent module.

H1

Complete Kit Ordering Instructions

D7P –	LFA	★	P	♣	X10E
Oper. Construction	Operator Type	Lens Color	Mounting Latch	Power Module	Contacts ②③
D7P - Plastic operator with plastic bezel (Type 4/4X/13, IP66)	LFA - Flush, maintained, illuminated	O - Amber 3 - Green 4 - Red 5 - Yellow 6 - Blue 7 - Clear 9 - No lens	P - Plastic latch (D7P and D7M offered with plastic latch as standard)	Integral LED module N3x, 24V AC/DC N5x, 120V AC N7x, 240V AC	X10E - 1NOEM X20E - 2NOEM X11E - 1NOEM/1NC X01 - 1NC X02 - 2NC
D7M - Metal operator with metal bezel (Type 4/13, IP66)		Custom printed diffusers sold separately, see Note ④	M - Metal latch		
			List price changes		

LED Module Code Selection	
For lens color...	replace "x" with...
Green	G
Red	R
Amber Yellow Blue Clear	W

→ Positive Opening per EN60947-5-1 (applies to all NC contact block styles)

① Legend plates sold separately. See page H6.11 for information.

② Up to 4 contact blocks can be attached.

③ See page H6.12 for complete kit ordering information on other special contact blocks and power modules

④ One blank inscription diffuser included. For custom printed diffuser, order operator with applicable lens cap color plus custom printed diffuser on page H6.14, sold separately.

⑤ D7x-LFA operator must be used with NOEM or NC contacts only. LED module required for illumination, cannot use incandescent module.

Standard Pushbuttons, Flush, Illuminated, Maintained (Components) ❶

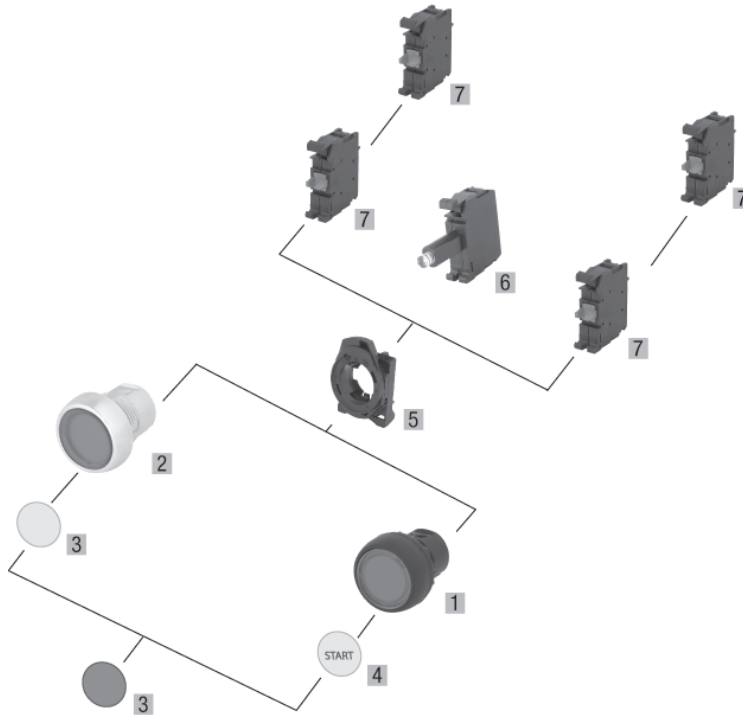

Component	Catalog Number	Pkg. Qty.
01 Illuminated plastic operator with plastic bezel, maintained, flush ❷❸	D7P-LFA9	1
02 Illuminated metal operator with shiny metal bezel, maintained, flush ❷❸	D7M-LFA9	1
03 Lens Cap (includes diffuser)	Amber D7-ALF0 Green D7-ALF3 Red D7-ALF4 Yellow D7-ALF5 Blue D7-ALF6 Clear D7-ALF7	10
04 Custom printed Inscription diffusers ❶❸	AUTO D7-AD2CE101 CLOSE D7-AD2CE107 DOWN D7-AD2CE110 FAULT D7-AD2CE113 FAST D7-AD2CE114 FORWARD D7-AD2CE120 HAND D7-AD2CE126 HIGH D7-AD2CE129 LOW D7-AD2CE148 OFF D7-AD2CE163 ON D7-AD2CE166 OPEN D7-AD2CE170 REVERSE D7-AD2CE188 RUN D7-AD2CE193 SLOW D7-AD2CE201 START D7-AD2CE208 STOP D7-AD2CE212 UP D7-AD2CE223	1

Component	Catalog Number	Pkg. Qty.
05 Tool-less Mounting Latch (for snap-on contact blocks and power modules)	Plastic Latch D7-ALP Metal Latch D7-ALM	10
06 Power Module, Integral LED ❷❸	24V AC/DC D7-N3x 120V AC D7-N5x 240V AC D7-N7x	10
07 Contact blocks ❷❸	NC D7-X01 NO, early D7-X10E make NC, low D7-X01V voltage	10

❶ Legend plates sold separately. See page H6:11 for information.
 ❷ Up to 4 contact blocks can be attached.
 ❸ See page H6:14 for other custom printed ISO and text options.

❹ To complete the catalog no., replace the "x" with one of the codes on the previous page.
 ❺ D7x-LFA operator must be used with NOEM or NC contacts only. LED module required for illumination, cannot use incandescent module.

Standard Pushbuttons, Extended, Illuminated (Complete Kits) ①

Contact Block(s) ②③	Plastic operator with plastic bezel	Metal operator with metal bezel
		
	Momentary ④	Momentary ④
Catalog Number	Catalog Number	
Oper. Only	D7P-LE③	D7M-LE③
Incandescent Module (Bulb Included)		
1NO	D7P-LE③P♣X10	D7M-LE③P♣X10
1NC	D7P-LE③P♣X01	D7M-LE③P♣X01
2NO	D7P-LE③P♣X20	D7M-LE③P♣X20
2NC	D7P-LE③P♣X02	D7M-LE③P♣X02
1NO/1NC	D7P-LE③P♣X11	D7M-LE③P♣X11
Integral LED Module		
1NO	D7P-LE③P♣X10	D7M-LE③P♣X10
1NC	D7P-LE③P♣X01	D7M-LE③P♣X01
2NO	D7P-LE③P♣X20	D7M-LE③P♣X20
2NC	D7P-LE③P♣X02	D7M-LE③P♣X02
1NO/1NC	D7P-LE③P♣X11	D7M-LE③P♣X11

Push to test Indicating Light Schematic

PUSH-TO-TEST INDICATING LIGHT CIRCUIT

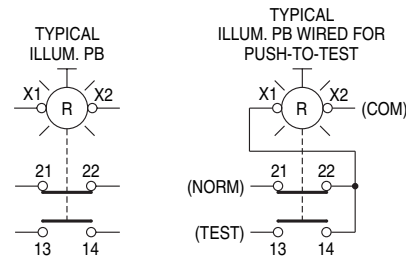

FIGURE 1

See applicable codes and laws

Complete Kit Ordering Instructions

D7P –	LE	★	P	♣	X10
Oper. Construction	Operator Type	Lens Color	Mounting Latch	Power Module	Contacts ②③
D7P - Plastic operator with plastic bezel (Type 4/4X/13, IP66)	LE - Extended, momentary, illuminated	0 - Amber 3 - Green 4 - Red 5 - Yellow 6 - Blue 7 - Clear 9 - No Lens	P - Plastic latch (D7P and D7M offered with plastic latch as standard) M - Metal latch List price changes	Incandescent module D0 - no bulb D1 - 6V, bulb D2 - 12V, bulb D3 - 24V, bulb D4 - 48V, bulb D5 - 120V, bulb Integral LED module N3x, 24V AC/DC N5x, 120V AC N7x, 240V AC	X10 - 1NO X01 - 1NC Ⓢ X20 - 2NO X02 - 2NC X11 - 1NO/1NC
D7M - Metal operator with metal bezel (Type 4/13, IP66)		Custom printed diffusers sold separately, see Note ④			

LED Module Code Selection	
For lens color...	replace "x" with...
Green	G
Red	R
Amber Yellow Blue Clear	W

Ⓢ Positive Opening per EN60947-5-1 (applies to all NC contact block styles)

① Legend plates sold separately. See page H6.11 for information.

② Up to 4 contact blocks can be attached.

③ See page H6.12 for complete kit ordering information on other special contact blocks and power modules.

④ One blank inscription diffuser included. For custom printed diffuser, order operator with applicable lens cap color plus custom printed diffuser on page H6.14, sold separately.

Standard Pushbuttons, Extended, Illuminated (Components) ❶

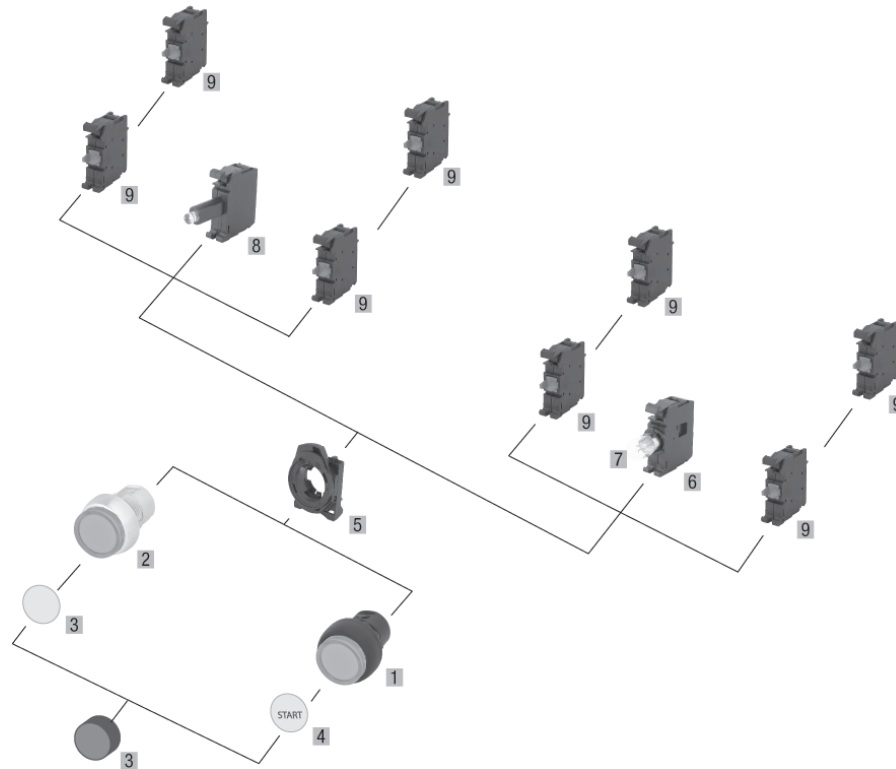

Component	Catalog Number	Pkg. Qty.
01 Illuminated plastic operator with plastic bezel, momentary, flush	D7P-LE9	1
02 Illuminated metal operator with shiny metal bezel, momentary, flush	D7M-LE9	1
03 Lens Cap (includes blank diffuser)	D7-ALE0 D7-ALE3 D7-ALE4 D7-ALE5 D7-ALE6 D7-ALE7	10
04 Custom printed Inscription diffusers ❶❷	D7-AD4CE101 D7-AD4CE107 D7-AD4CE110 D7-AD4CE113 D7-AD4CE114 D7-AD4CE120 D7-AD4CE126 D7-AD4CE129 D7-AD4CE148 D7-AD4CE163 D7-AD4CE166 D7-AD4CE170 D7-AD4CE188 D7-AD4CE193 D7-AD4CE201 D7-AD4CE208 D7-AD4CE212 D7-AD4CE223	1

Component	Catalog Number	Pkg. Qty.
05 Tool-less Mounting Latch (for snap-on contact blocks and power modules)	D7-ALP D7-ALM	10
06 Power Module, Incandescent	D7-D0C	10
07 Lamps, Incandescent	D7-N65 D7-N141 D7-N157 D7-N48 D7-N130	10
08 Power Module, Integral LED ❸	D7-N3x D7-N5x D7-N7x	10
09 Contact blocks ❹	D7-X10 D7-X01 D7-X10V ❺ D7-X01V ❻	10

- ❶ Legend plates sold separately. See page H6:11 for information.
- ❷ Up to 4 contact blocks can be attached.
- ❸ See page H6:14 for other custom printed ISO and text options.
- ❹ To complete the catalog no., replace the "x" with one of the codes on the previous page.
- ❺ Low voltage contact blocks must be ordered separately.

Standard Pushbuttons, Mushroom, Momentary, Illuminated (Complete Kits) ③

Contact Block(s) ①②	Plastic operator with plastic bezel	Metal operator with metal bezel
		
	40mm Mushroom ③	40mm Mushroom ③
Catalog Number		Catalog Number
Oper. Only	D7P-LMM4 ④	D7M-LMM4 ④
Incandescent Module (Bulb Included)		
1NO	D7P-LMM4 ④ P X10	D7M-LMM4 ④ P X10
1NC	D7P-LMM4 ④ P X01	D7M-LMM4 ④ P X01
2NO	D7P-LMM4 ④ P X20	D7M-LMM4 ④ P X20
2NC	D7P-LMM4 ④ P X02	D7M-LMM4 ④ P X02
1NO/1NC	D7P-LMM4 ④ P X11	D7M-LMM4 ④ P X11
Integral LED Module		
1NO	D7P-LMM4 ④ P X10	D7M-LMM4 ④ P X10
1NC	D7P-LMM4 ④ P X01	D7M-LMM4 ④ P X01
2NO	D7P-LMM4 ④ P X20	D7M-LMM4 ④ P X20
2NC	D7P-LMM4 ④ P X02	D7M-LMM4 ④ P X02
1NO/1NC	D7P-LMM4 ④ P X11	D7M-LMM4 ④ P X11

H1

D7 Pilot Devices

Complete Kit Ordering Instructions

D7P	-	LMM4	★	P	♣	X10
Oper. Construction		Operator Type	Lens Color	Mounting Latch	Power Module	Contacts ①②
D7P - Plastic operator with plastic bezel (Type 4/4X/13, IP65)		LMM4 - Mushroom, 40mm, momentary, illuminated	3 - Green 4 - Red 5 - Yellow 6 - Blue 7 - Clear	P - Plastic latch (D7P and D7M offered with plastic latch as standard) M - Metal latch List price changes	Incandescent module D0 - no bulb D1 - 6V, bulb D2 - 12V, bulb D3 - 24V, bulb D4 - 48V, bulb D5 - 120V, bulb Integral LED module N3x, 24V AC/DC N5x, 120V AC N7x, 240V AC	X10 - 1NO X01 - 1NC ③ X20 - 2NO X02 - 2NC X11 - 1NO/1NC

LED Module Code Selection	
For lens color...	replace "x" with...
Green	G
Red	R
Yellow Blue Clear	W

③ Positive Opening per EN60947-5-1 (applies to all NC contact block styles)

- ① Up to 4 contact blocks can be attached.
- ② See page H6:12 for complete kit ordering information on other special contact blocks and power modules.
- ③ Not available with inscriptions. Order inscription ring or legend plate for identification. See pages H6:6 and H6:11 for information.

Standard Pushbuttons, Mushroom, Momentary, Illuminated (Components) ❶

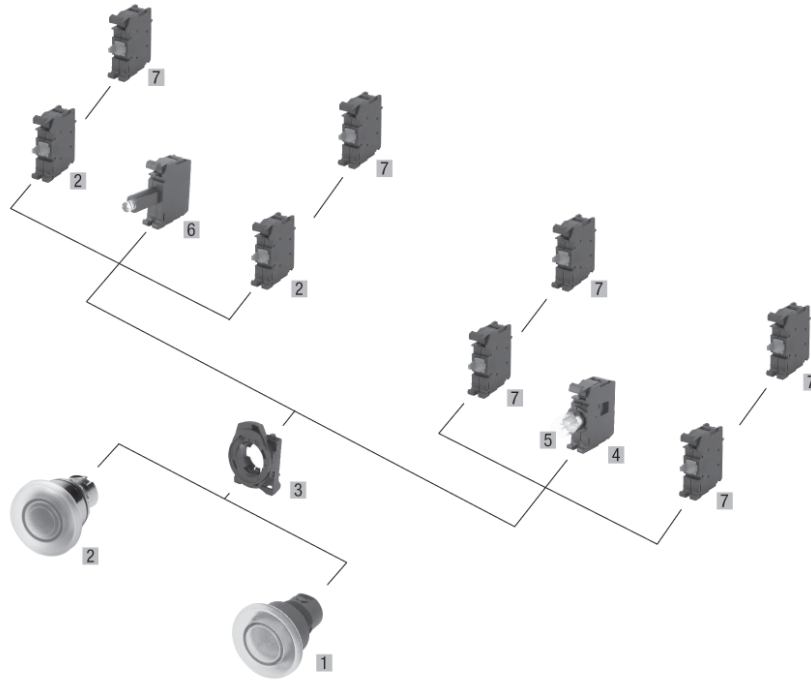

Component	Catalog Number	Pkg. Qty.
01 Plastic operator with plastic bezel, momentary, 40mm mushroom, illuminated ❶ Green Red Yellow Blue Clear	D7P-LMM43 D7P-LMM44 D7P-LMM45 D7P-LMM46 D7P-LMM47	1
02 Metal operator with metal bezel, momentary, 40mm mushroom, illuminated ❶ Green Red Yellow Blue Clear	D7M-LMM43 D7M-LMM44 D7M-LMM45 D7M-LMM46 D7M-LMM47	1
03 Tool-less Mounting Latch (for snap-on contact blocks and power modules) Plastic Latch Metal Latch	D7-ALP D7-ALM	10
04 Power Module, Incandescent	D7-DOC	10
05 Lamps, Incandescent 6V AC/DC 12V AC/DC 24V AC/DC 48V AC/DC 130V AC/DC	D7-N65 D7-N141 D7-N157 D7-N48 D7-N130	10

Component	Catalog Number	Pkg. Qty.
06 Power Module, Integral LED ❷ 24V AC/DC 120V AC 240V AC	D7-N3x D7-N5x D7-N7x	10
07 Contact blocks ❸ NO NC NO, low voltage NC, low voltage	D7-X10 D7-X01 D7-X10V ❹ D7-X01V ❹	10



❶ Not available with inscriptions. Order inscription ring or legend plate for identification. See pages H6.6 and H6.11 for information.

❷ Up to 4 contact blocks can be attached.

❸ To complete the catalog no., replace the "x" with one of the codes on the previous page.

❹ Low voltage contact blocks must be ordered separately.

Two Position Operators, Push-pull (Trigger Action), Non-illuminated (Complete Kit) ③④⑤⑥

Contact Block(s) ①②	Plastic operator with plastic bezel	Metal operator with metal bezel
		
	40mm Color Cap ③	40mm Color Cap ③
Catalog Number	Catalog Number	Catalog Number
Oper. Only	D7P-MP4 ④	D7M-MP4 ④
1NO	D7P-MP4 ④ PX10	D7M-MP4 ④ PX10
1NC	D7P-MP4 ④ PX01	D7M-MP4 ④ PX01
GCB	D7P-MP4 ④ PX01S	D7M-MP4 ④ PX01S
2NO	D7P-MP4 ④ PX20	D7M-MP4 ④ PX20
2NC	D7P-MP4 ④ PX02	D7M-MP4 ④ PX02
1NO/1NC	D7P-MP4 ④ PX11	D7M-MP4 ④ PX11
3NO	D7P-MP4 ④ PX30	D7M-MP4 ④ PX30
3NC	D7P-MP4 ④ PX03	D7M-MP4 ④ PX03
2NO/1NC	D7P-MP4 ④ PX21	D7M-MP4 ④ PX21
1NO/2NC	D7P-MP4 ④ PX12	D7M-MP4 ④ PX12

H1

D7 Pilot Devices

Complete Kit Ordering Instructions

D7P –	MP4	★	P	X10
Oper. Construction	Operator Type	Color Cap ③	Mounting Latch	Contacts ①②
D7P - Plastic operator with plastic bezel (Type 4/4X/13, IP66)	MP4 - 2-position, 40mm mushroom, push-pull, non-illuminated	2 - Black 3 - Green 4 - Red 5 - Yellow 6 - Blue	P - Plastic latch <i>(D7P and D7M offered with plastic latch as standard)</i> Metal latch M - List price changes	X10 - 1NO X01 - 1NC → X20 - 2NO X02 - 2NC X11 - 1NO/1NC X30 - 3NO X03 - 3NC X21 - 2NO/1NC X12 - 1NO/2NC

Colors in Gray are **SPECIAL ORDER**

→ Positive Opening per EN60947-5-1 (applies to all NC contact block styles)

- ① Up to 6 contact blocks (3 across / 2 high) can be attached.
- ② See page H6:7 for complete kit ordering information on other special contact blocks: Early make, late break, low voltage, contact blocks.
- ③ Not available with inscriptions. Order inscription ring or legend plate for identification. See pages H6:6 and H6:11 for information.
- ④ Operators are EN ISO13850 compliant with standard NC, NCLB or Guardian contact blocks.
- ⑤ For EMO Guards, see page H6:10.
- ⑥ Operators, latch, and contact block combinations have been third-party tested for B10d values. B10d values can be found in approval document EL660_01_10 online at www.sprecherschuh.com.

Two Position Operators, Push-pull (Trigger Action), Non-illuminated (Components) ❶

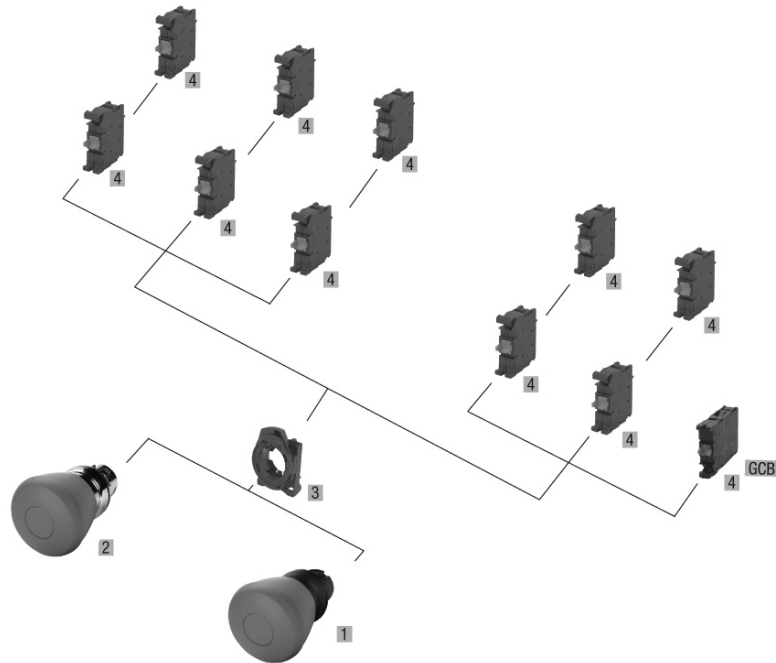



Component	Catalog Number	Pkg. Qty.
01 Plastic operator with plastic bezel, 2-position, 40mm, push-pull ❶ Black Green Red Yellow Blue	D7P-MP42 D7P-MP43 D7P-MP44 D7P-MP45 D7P-MP46	1
02 Metal operator with metal bezel, 2-position, 40mm, push-pull ❶ Black Green Red Yellow Blue	D7M-MP42 D7M-MP43 D7M-MP44 D7M-MP45 D7M-MP46	1
03 Tool-less Mounting Latch (for snap-on contact blocks and power modules) Plastic Latch Metal Latch	D7-ALP D7-ALM	10
04 Contact blocks ❷ NO NC GCB, Guardian Block	D7-X10 D7-X01 ⇄ D7-X01S ⇄ D7-X01S ⇄	10

Colors in Gray are **SPECIAL ORDER**

⇄ Positive Opening per EN60947-5-1 (applies to all NC contact block styles)

❶ Not available with inscriptions. Order inscription ring or legend plate for identification. See pages H6:6 and H6:11 for information.
❷ Up to 6 contact blocks (3 across / 2 high) can be attached.

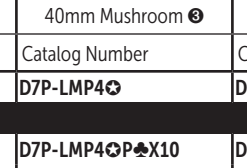
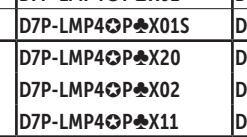
Two Position Operators, Push-Pull, Illuminated (Complete Kits) ③④⑥⑧

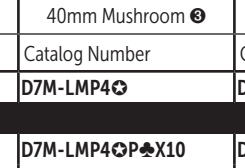
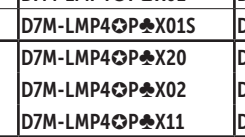
Contact Block(s) ①②	Plastic operator with plastic bezel			Metal operator with metal bezel		
						
	30mm Mushroom ③	40mm Mushroom ③	60mm Mushroom ③	30mm Mushroom ③	40mm Mushroom ③	60mm Mushroom ③
	Catalog Number	Catalog Number	Catalog Number	Catalog Number	Catalog Number	Catalog Number
Oper. Only	D7P-LMP3④	D7P-LMP4④	D7P-LMP6④	D7M-LMP3④	D7M-LMP4④	D7M-LMP6④
Integral LED Module						
1NO	D7P-LMP3④P♣X10	D7P-LMP4④P♣X10	D7P-LMP6④P♣X10	D7M-LMP3④P♣X10	D7M-LMP4④P♣X10	D7M-LMP6④P♣X10
1NC	D7P-LMP3④P♣X01	D7P-LMP4④P♣X01	D7P-LMP6④P♣X01	D7M-LMP3④P♣X01	D7M-LMP4④P♣X01	D7M-LMP6④P♣X01
GCB	D7P-LMP3④P♣X01S	D7P-LMP4④P♣X01S	D7P-LMP6④P♣X01S	D7M-LMP3④P♣X01S	D7M-LMP4④P♣X01S	D7M-LMP6④P♣X01S
2NO	D7P-LMP3④P♣X20	D7P-LMP4④P♣X20	D7P-LMP6④P♣X20	D7M-LMP3④P♣X20	D7M-LMP4④P♣X20	D7M-LMP6④P♣X20
2NC	D7P-LMP3④P♣X02	D7P-LMP4④P♣X02	D7P-LMP6④P♣X02	D7M-LMP3④P♣X02	D7M-LMP4④P♣X02	D7M-LMP6④P♣X02
1NO/1NC	D7P-LMP3④P♣X11	D7P-LMP4④P♣X11	D7P-LMP6④P♣X11	D7M-LMP3④P♣X11	D7M-LMP4④P♣X11	D7M-LMP6④P♣X11

H1

Complete Kit Ordering Instructions

D7P –	LMP3	★	P	♣	X10
Oper. Construction	Operator Type	Lens Color	Mounting Latch	Power Module ④	Contacts ①②
D7P - Plastic operator with plastic bezel (Type 4/4X/13, IP66)	LMP3 - 2-position, 30mm mushroom, push-pull, illuminated	3 - Green 4 - Red 5 - Yellow ⑥ 6 - Blue ⑥⑦	P - Plastic latch (D7P and D7M offered with plastic latch as standard)	Integral LED module N3x, 24V AC/DC N5x, 120V AC N7x, 240V AC	X10 - 1NO X01 - 1NC X20 - 2NO X02 - 2NC X11 - 1NO/1NC
D7M - Metal operator with metal bezel (Type 4/13, IP66)	LMP4 - 2-position, 40mm mushroom, push-pull, illuminated LMP6 - 2-position, 60mm mushroom, push-pull, illuminated		M - Metal latch List price changes		

➡ Positive Opening per EN60947-5-1 (applies to all NC contact block styles)

LED Module Code Selection	
For lens color...	replace "x" with
Green	G
Red	R
Blue Yellow	W

- ① Up to 4 contact blocks can be attached.
- ② See page H6:7 for complete kit ordering information on other special contact blocks and power modules.
- ③ Not available with inscriptions. Order inscription ring or legend plate for identification. See pages H6:6 and H6:11 for information.
- ④ Integral LED module required for illumination, cannot use incandescent module.
- ⑤ To complete the catalog no., replace the x with one of the following letters for desired color: R = Red, G = Green, W = White for Yellow and Blue lens color.

- ⑥ Operators are EN-ISO13850 compliant with standard NC, NCLB or Guardian contact blocks.
- ⑦ Only available on 40mm operators.
- ⑧ Operators, latch, and contact block combinations have been third-party tested for B10d values. B10d values can be found in approval document EL660_01_10 online at www.sprecherschuh.com.

Two Position Operators, Push-Pull, Illuminated (Components) ❶

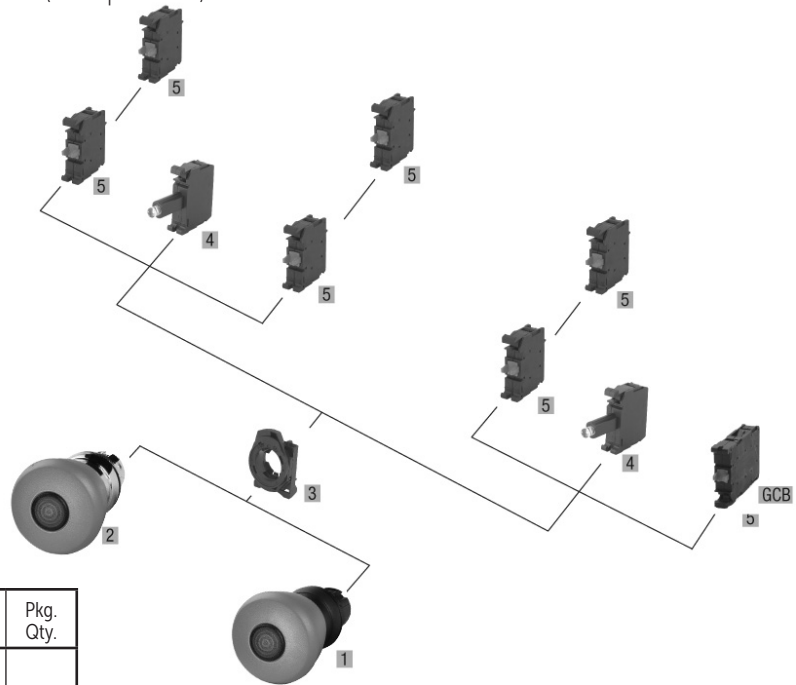



Component	Catalog Number	Pkg. Qty.
01 Plastic operator with plastic bezel, 2-position, 30mm push-pull, illuminated ❶❸	D7P-LMP33 D7P-LMP34 D7P-LMP35	1
Green		
Red		
Yellow		
Plastic operator with plastic bezel, 2-position, 40mm push-pull, illuminated ❶❸	D7P-LMP43 D7P-LMP44 D7P-LMP45 D7P-LMP46	1
Green		
Red		
Yellow		
Blue		
Plastic operator with plastic bezel, 2-position, 60mm push-pull, illuminated ❶❸	D7P-LMP63 D7P-LMP64 D7P-LMP65	1
Green		
Red		
Yellow		
02 Metal operator with metal bezel, 2-position, 30mm push-pull, illuminated ❶❸	D7M-LMP33 D7M-LMP34 D7M-LMP35	1
Green		
Red		
Yellow		
Metal operator with metal bezel, 2-position, 40mm push-pull, illuminated ❶❸	D7M-LMP43 D7M-LMP44 D7M-LMP45 D7M-LMP46	1
Green		
Red		
Yellow		
Blue		
Metal operator with metal bezel, 2-position, 60mm push-pull, illuminated ❶❸	D7M-LMP63 D7M-LMP64 D7M-LMP65	1
Green		
Red		
Yellow		

Component	Catalog Number	Pkg. Qty.
03 Tool-less Mounting Latch (for snap-on contact blocks and power modules)	D7-ALP D7-ALM	10
Plastic Latch		
Metal Latch		
04 Power Module, Integral LED ❷	D7-N3x D7-N5x D7-N7x	10
24V AC/DC		
120V AC		
240V AC		
05 Contact blocks ❷	D7-X10 D7-X01 ⇄	10
NO		
NC		
NO, low voltage		
NC, low voltage		
GCB, Guardian Block		
	D7-X10V ❸	
	D7-X01V ⇄ ❸	
	D7-X01S ⇄	

⇄ Positive Opening per EN60947-5-1 (applies to all NC contact block styles)

- ❶ Not available with inscriptions. Order inscription ring or legend plate for identification. See pages H6:6 and H6:11 for information.
- ❷ Up to 4 contact blocks can be attached.
- ❸ Integral LED module required for illumination cannot use incandescent module.
- ❹ To complete the catalog no., replace the x with one of the following letters for desired color: R = Red, G = Green, W = White for Yellow and Blue lens color.
- ❺ Low voltage contact blocks must be ordered separately.

Three Position, Push-Pull, Non-Illuminated (Operator Only) ①②③

Metal operator with metal bezel 	Metal operator with metal bezel 
40mm Mushroom, Momentary	40mm Mushroom, Maintained
Catalog Number	Catalog Number
D7M-MM4E3	D7M-MP4E3



Important Note:

Cannot use N.C. or N.O.E.M. contact blocks with 3 position push-pull operators. Contact blocks and mounting latches sold separately, see next page.

Ordering Instructions (Operator Only)

D7M	–	MM	4	★	E3
Operator Construction D7M - Metal operator with metal bezel (Type 4/13, IP66)		Operator Type MM - 3 position, 40 mm mushroom, push-pull Non-illuminated momentary out, maintained center, momentary in MP - 3 position, 40 mm Mushroom, push-pull Non-illuminated momentary out, maintained center, maintained in	Cap Size 4 - 40mm Plastic	Cap Color 2 - Black 3 - Green 4 - Red	Positions E3 - 3 Position

Target Table and Operator Positions

			
Contact Type	Out	Center	In
N.O.	O	O	X
N.C.E.B	X	O	O
N.C.L.B.	X	X	O

Note: X = Closed/ O = Open

- ① Not available with inscriptions. Order inscription ring or legend plate for identification. See pages H6:6 and H6:11 for information.
- ② Up to 6 contact blocks (3 across / 2 high) can be attached.
- ③ Cannot use N.C. or NOEM contact blocks with 3 position push-pull operators. Contact blocks and mounting latches sold separately, see next page.

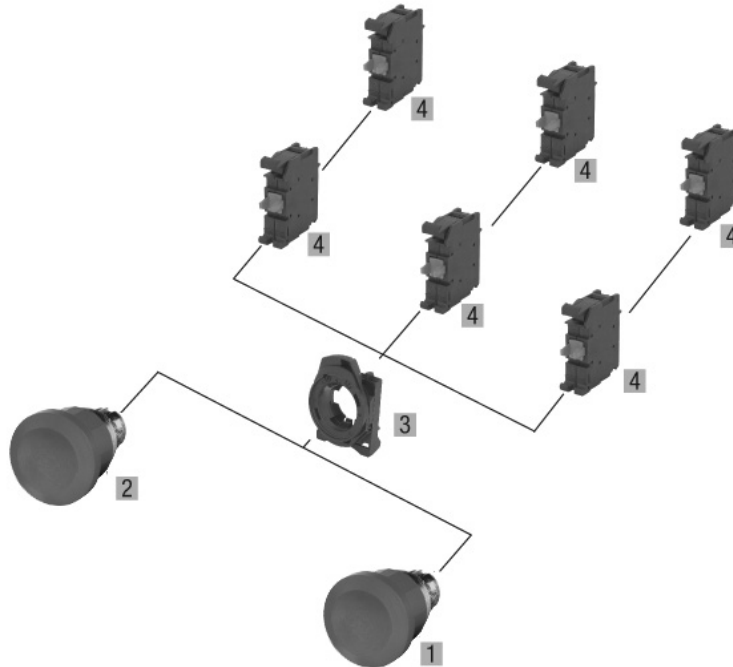

Three Position, Push-Pull, Non-Illuminated (Components)



Component	Catalog Number	Pkg. Qty.
01 Metal operator with shiny metal bezel momentary, 40mm Mushroom, non-illuminated momentary out, maintained center, momentary in ❶ Black Green Red	D7M-MM42E3 D7M-MM43E3 D7M-MM44E3	1
02 Metal operator with shiny metal bezel momentary, 40mm Mushroom, non-illuminated momentary out, maintained center, maintained in ❶ Black Green Red	D7M-MP42E3 D7M-MP43E3 D7M-MP44E3	1
03 Tool-less Mounting Latch (for snap-on contact blocks and power modules) Plastic Latch Metal Latch	D7-ALP D7-ALM	10
04 Contact Blocks ❷❸ NO NCLB NCEB	D7-X10 D7-X01L D7-X01B	10

- ❶ Not available with inscriptions. Order inscription ring or legend plate for identification. See pages H6:6 and H6:11 for information.
- ❷ Up to 6 contact blocks (3 across / 2 high) can be attached.
- ❸ Cannot use N.C. or NOEM contact blocks with 3 position push-pull operators



Three Position, Push-Pull, Illuminated (Operator Only) ①②④

		Important Note: <ul style="list-style-type: none"> • Cannot use N.C. or N.O.E.M. contact blocks with 3-position push-pull operators. • Integral LED module required for illumination, cannot use incandescent module. • Contact blocks, mounting latches and light modules sold separately, see next page to order.
40mm Mushroom, Momentary	40mm Mushroom, Maintained	
Catalog Number	Catalog Number	
D7M-LMM4⊕E3	D7M-LMP4⊕E3	

Ordering Instructions (Operator Only)

D7M	–	LMM	4	★	E3
<u>Operator</u>		<u>Operator Type</u>	<u>Cap Size</u>	<u>Cap/Lens Color</u>	<u>Positions</u>
D7M - Metal operator with metal bezel (Type 4/13, IP66)		LMM - 3 position, 40mm mushroom, push-pull illuminated momentary out, maintained center, momentary in LMP - 3 position, 40mm mushroom, push-pull illuminated momentary out, maintained center, maintained in	4 - 40mm Plastic	0- Amber 3 - Green 4 - Red 6 - Blue 7 - Clear	E3 - 3 Position

H1
D7 Pilot Devices

Target Table and Operator Positions ③④			
			
Contact Type	Out	Center	In
N.O.	O	O	X
N.C.E.B	X	O	O
N.C.L.B.	X	X	O

Note: X = Closed/ O = Open

- ① Not available with inscriptions. Order inscription ring or legend plate for identification. See pages H6:6 and H6:11 for information.
- ② Integral LED module required for illumination, cannot use incandescent module.
- ③ Up to 4 contact blocks can be attached.
- ④ Cannot use N.C. or NOEM contact blocks with 3-position push-pull operators. Must use N.O., N.C.E.B., or N.C.L.B. contact blocks.

Three Position, Push-Pull, Illuminated (Components)

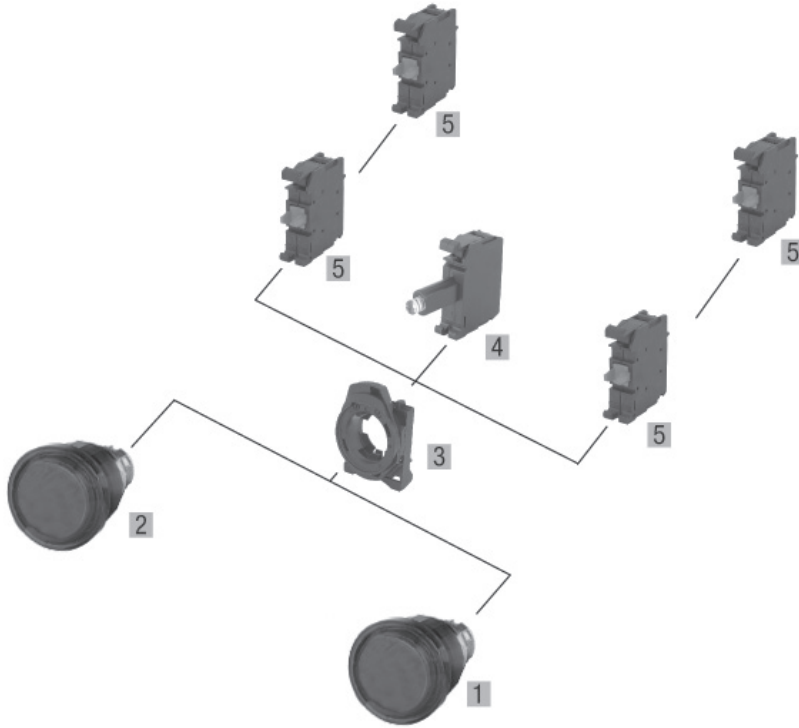

Component	Catalog Number	Price Ea.	Pkg. Qty.
01 Metal operator with metal bezel momentary, 40mm Mushroom, illuminated momentary out, maintained center, momentary in ❶ Amber Green Red Blue Clear	D7M-LMM40E3 D7M-LMM43E3 D7M-LMM44E3 D7M-LMM46E3 D7M-LMM47E3	94.64	1
02 Metal operator with metal bezel momentary, 40mm Mushroom, illuminated momentary out, maintained center, maintained in ❶ Amber Green Red Blue Clear	D7M-LMP40E3 D7M-LMP43E3 D7M-LMP44E3 D7M-LMP46E3 D7M-LMP47E3	94.64	1
03 Tool-less Mounting Latch Plastic Latch Metal Latch	D7-ALP D7-ALM	6.03 7.75	10
04 Power Module, Integral LED module ❷ 24V AC/DC 120V AC 240V AC	D7-N3x D7-N5x D7-N7x	32.82	10
05 Contact Blocks ❸❹ NO NCLB NCEB	D7-X10 D7-X01L D7-X01B	13.74	10

LED Module Code Selection	
For lens color...	replace "x" with...
Green	G
Red	R
Amber Blue Clear	W

- ❶ Not available with inscriptions. Order inscription ring or legend plate for identification. See pages H6:6 and H6:11 for information.w
- ❷ Up to 4 contact blocks can be attached.
- ❸ Cannot use N.C. or NOEM contact blocks with 3-position push-pull operators.

Emergency Stop Operators, Twist-to-release (Trigger Action), Non-keyed (Complete Kit) ③⑤⑥

Contact Block(s) ①②	Plastic operator with plastic bezel			Metal operator with metal bezel		
	30mm Color Cap ③	40mm Color Cap ③	60mm Color Cap ③	30mm Color Cap ③	40mm Color Cap ③	60mm Color Cap ③
	Catalog Number	Catalog Number	Catalog Number	Catalog Number	Catalog Number	Catalog Number
Oper. Only	D7P-MT34	D7P-MT44	D7P-MT64	D7M-MT34	D7M-MT44	D7M-MT64
1NO	D7P-MT34PX10	D7P-MT44PX10	D7P-MT64PX10	D7M-MT34PX10	D7M-MT44PX10	D7M-MT64PX10
1NC	D7P-MT34PX01	D7P-MT44PX01	D7P-MT64PX01	D7M-MT34PX01	D7M-MT44PX01	D7M-MT64PX01
GCB ④	D7P-MT34PX01S	D7P-MT44PX01S	D7P-MT64PX01S	D7M-MT34PX01S	D7M-MT44PX01S	D7M-MT64PX01S
2NO	D7P-MT34PX20	D7P-MT44PX20	D7P-MT64PX20	D7M-MT34PX20	D7M-MT44PX20	D7M-MT64PX20
2NC	D7P-MT34PX02	D7P-MT44PX02	D7P-MT64PX02	D7M-MT34PX02	D7M-MT44PX02	D7M-MT64PX02
1NO/1NC	D7P-MT34PX11	D7P-MT44PX11	D7P-MT64PX11	D7M-MT34PX11	D7M-MT44PX11	D7M-MT64PX11
3NO	D7P-MT34PX30	D7P-MT44PX30	D7P-MT64PX30	D7M-MT34PX30	D7M-MT44PX30	D7M-MT64PX30
3NC	D7P-MT34PX03	D7P-MT44PX03	D7P-MT64PX03	D7M-MT34PX03	D7M-MT44PX03	D7M-MT64PX03
2NO/1NC	D7P-MT34PX21	D7P-MT44PX21	D7P-MT64PX21	D7M-MT34PX21	D7M-MT44PX21	D7M-MT64PX21
1NO/2NC	D7P-MT34PX12	D7P-MT44PX12	D7P-MT64PX12	D7M-MT34PX12	D7M-MT44PX12	D7M-MT64PX12

Complete Kit Ordering Instructions

D7P –	MT4	4	P	X10
Oper. Construction	Operator Type	Color Cap ③	Mounting Latch	Contacts ①②④
D7P - Plastic operator with plastic bezel (Type 4/4X/13, IP66)	MT3 - 2-position, 30mm diameter, twist-to-release	4 - Red	P - Plastic latch (D7P and D7M offered with plastic latch as standard)	X10 - 1NO X01 - 1NC X20 - 2NO X02 - 2NC X11 - 1NO/1NC X30 - 3NO X03 - 3NC X21 - 2NO/1NC X12 - 1NO/2NC
D7M - Metal operator with metal bezel (Type 4/13, IP66)	MT4 - 2-position, 40mm diameter, twist-to-release MT6 - 2-position, 60mm diameter, twist-to-release		M - Metal latch List price changes	

→ Positive Opening per EN60947-5-1 (applies to all NC contact block styles)

"EMO" Emergency Stop Operator

40mm Emergency Stop metal and plastic operators are available with a special "EMO" inscription. To order:

- Select 40mm kit of choice
- Add suffix "E" to catalog number
Ex.: Change D7P-MT44PX01 to D7P-MT44E PX01
- List price changes.



Semicon compliant yellow plastic guards available, see page H6:10

- Up to 6 contact blocks (3 across / 2 high) can be attached.
- See page H6:12 for complete kit ordering information on other special contact blocks: Early make, late break, low voltage contact blocks.
- Order inscription ring or legend plate for identification. See pages H6:6 and H6:11 for information.
- When ordering E-Stop Complete Kits with Guardian Contact Blocks, additional NO and NC contact blocks should be ordered as components from the opposite page.

- Operators are EN-ISO13850 compliant with standard NC, NCLB or Guardian contact blocks.
- Operators, latch, and contact block combinations have been third-party tested for B10d values. B10d values can be found in approval document EL660_01_10 online at www.sprecherschuh.com.

Emergency Stop Operators, Twist-to-release (Trigger Action), Non-keyed (Components) ①

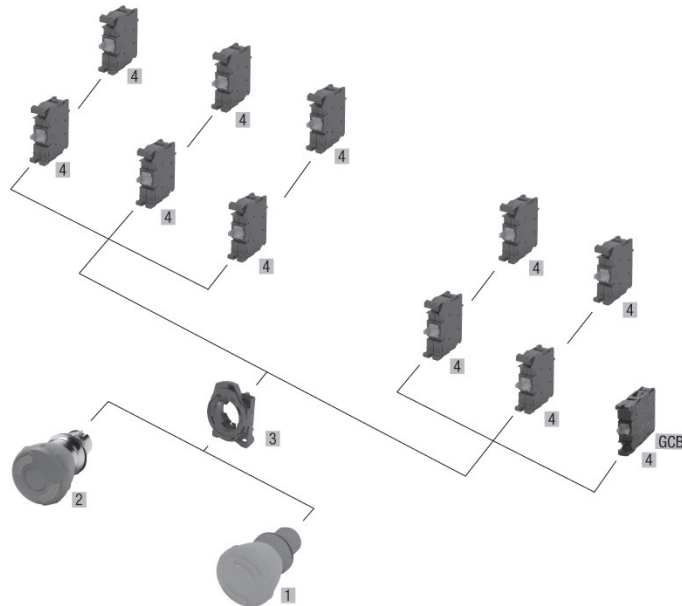

Component	Catalog Number	Pkg. Qty.
01 Plastic operator with plastic bezel, 30mm Red, Twist-to-release ①	D7P-MT34	1
Plastic operator with plastic bezel, 40mm Red Twist-to-release ① ③	D7P-MT44	
Plastic operator with plastic bezel, 60mm Red, Twist-to-release ①	D7P-MT64	
02 Metal operator with shiny metal bezel, 30mm Red, Twist-to-release ①	D7M-MT34	1
Metal operator with shiny metal bezel, 40mm Red, Twist-to-release ① ③	D7M-MT44	
Metal operator with shiny metal bezel, 60mm Red, Twist-to-release ①	D7M-MT64	
03 Tool-less Mounting Latch (for snap-on contact blocks and power modules) Plastic Latch Metal Latch	D7-ALP D7-ALM	10
04 Contact blocks ② NO NC NO, low voltage NC, low voltage GCB, Guardian Block	D7-X10 D7-X01 ⇄ D7-X10V ⇄④ D7-X01V ④ D7-X01S ⇄	10

⇄ Positive Opening per EN60947-5-1 (applies to all NC contact block styles)

- ① Not available with inscriptions. Order inscription ring or legend plate for identification. See pages H6.6 and H6.11 for information.
- ② Up to 6 contact blocks (3 across / 2 high) can be attached. Up to 4 contact blocks for the Guardian block.
- ③ For special "EMO" inscription, add suffix "E" to catalog number. For example change D7P-MT44 to D7P-MT44E. List price changes
- ④ Low voltage contact blocks must be ordered separately.

E-Stop Guardian® Contact Blocks (D7-X01S)

Separation of the contact blocks from the front operator or mounting latch can prevent an E-Stop from shutting down the controlled process in an emergency. Proper contact block installation is critical to ensure that the normally closed contacts will open when the E-Stop is actuated.

Designed for critical control applications, Sprecher + Schuh's new Guardian Contact Block (GCB) monitors itself to assure it is properly installed on E-Stop operators.

A normally open Guardian contact is physically molded and wired in series with a standard set of normally closed (NC) contacts. The normally open Guardian contacts automatically close when the contact block is properly installed on the E-Stop operator ①. In this state, the E-Stop and NC contacts operate as usual, with actuation of the E-Stop causing the NC contacts to open ②.

If the contact block should separate from the E-Stop operator, the normally open Guardian contacts will automatically open ③. Because the Guardian contacts are wired in series with the NC contacts, the opening of either set of contacts will open the circuit being controlled by the E-Stop.

	① Normal Operation	② Actuated Button	③ Improperly Installed
N.O. G.C.B.	X	X	0
N.C.	X	0	X
.1 ———— 2	X	0	0

Emergency Stop Operators, Twist-to-release (Trigger Action), Keyed (Complete Kit) ③⑤⑥⑧

Contact Block(s) ①②	Plastic operator with plastic bezel	Metal operator with metal bezel
		
	40mm Color Cap ③④	40mm Color Cap ③④
Catalog Number	Catalog Number	Catalog Number
Oper. Only	D7P-MK44 ⑤	D7M-MK44 ⑤
1NO	D7P-MK44PX10	D7M-MK44PX10
1NC	D7P-MK44PX01	D7M-MK44PX01
GCB ④	D7P-MK44PX01S	D7M-MK44PX01S
2NO	D7P-MK44PX20	D7M-MK44PX20
2NC	D7P-MK44PX02	D7M-MK44PX02
1NO/1NC	D7P-MK44PX11	D7M-MK44PX11
3NO	D7P-MK44PX30	D7M-MK44PX30
3NC	D7P-MK44PX03	D7M-MK44PX03
2NO/1NC	D7P-MK44PX21	D7M-MK44PX21
1NO/2NC	D7P-MK44PX12	D7M-MK44PX12

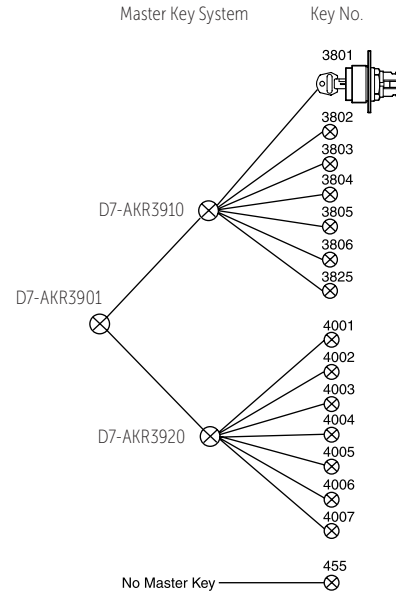

H2
D7 Pilot Devices

Complete Kit Ordering Instructions

D7P –	MK4	4	★	P	X10
Oper. Construction D7P - Plastic operator with plastic bezel (Type 4/4X/13, IP66) D7M - Metal operator with metal bezel (Type 4/13, IP66)	Operator Type MK4 - 2-position, 40mm diameter, keyed, twist-to-release	Color Cap ③ 4 - Red	Key Code ⑦ Omit this position for a standard key (3825) Ronis Key Lock Key Code Key No. Blank 3825 (Standard) R 455 01R 3801 02R 3802 03R 3803 04R 3804 05R 3805 06R 3806 27R 4001 28R 4002 29R 4003 30R 4004 31R 4005 32R 4006 33R 4007	Mounting Latch P - Plastic latch (D7P and D7M offered with plastic latch as standard) M - Metal latch List price changes	Contacts ①②④ X10 - 1NO X01 - 1NC → X20 - 2NO X02 - 2NC X11 - 1NO/1NC X30 - 3NO X03 - 3NC X21 - 2NO/1NC X12 - 1NO/2NC

* Shading denotes special order.

→ Positive Opening per EN60947-5-1 (applies to all NC contact block styles)

- Up to 6 contact blocks (3 across / 2 high) can be attached.
- See page H6:12 for complete kit ordering information on other special contact blocks: Early make, late break, low voltage contact blocks.
- Not available with inscriptions. Order inscription ring or legend plate for identification. See pages H6:6 and H6:11 for information.
- When ordering E-Stop Complete Kits with Guardian Contact Blocks, additional NO and NC contact blocks should be ordered as components from the opposite page. Equipped with one set (two keys) of the selected Ronis Key. For Ronis replacement keys, see Accessories page H6:8.
- Operators are EN-ISO13850 compliant with standard NC, NCLB or Guardian contact blocks.
- Not intended for high security applications. Interoperability is possible with certain key/cylinder lock combinations
- Key removal from maintained depressed position only.
- Operators, latch, and contact block combinations have been third-party tested for B10d values. B10d values can be found in approval document EL660_01_10 online at www.sprechersschuh.com.

Emergency Stop Operators, Twist-to-release (Trigger Action), Keyed (Components) ❶

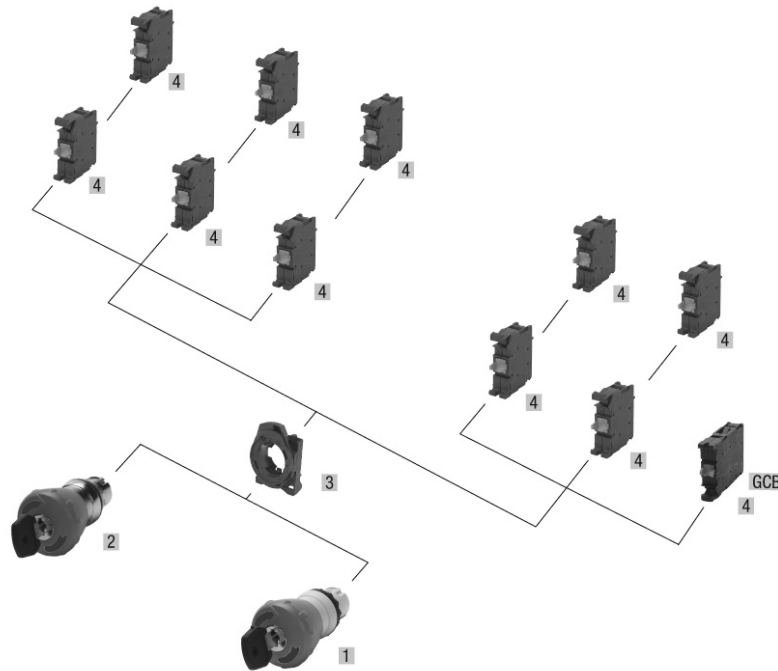

Component	Catalog Number	Pkg. Qty.
01 Plastic operator with plastic bezel, 40mm Red, keyed, Twist-to-release ❶❸	D7P-MK44 ⊕	1
02 Metal operator with shiny metal bezel, 40mm Red, keyed, Twist-to-release ❶❸	D7M-MK44 ⊕	1
03 Tool-less Mounting Latch (for snap-on contact blocks and power modules) Plastic Latch Metal Latch	D7-ALP D7-ALM	10
04 Contact blocks ❷ NO NC GCB, Guardian Block	D7-X10 D7-X01 ⊕ D7-X01S ⊕	10

See "Complete Assembly Ordering Instructions" chart on opposite page to determine "Key Codes" (⊕) if applicable.

⊕ Positive Opening per EN60947-5-1 (applies to all NC contact block styles)

E-Stop Guardian™ Contact Blocks (D7-X01S)

Separation of the contact blocks from the front operator or mounting latch can prevent an E-Stop from shutting down the controlled process in an emergency. Proper contact block installation is critical to ensure that the normally closed contacts will open when the E-Stop is actuated.

Designed for critical control applications, Sprecher + Schuh's new Guardian Contact Block (GCB) monitors itself to assure it is properly installed on E-Stop operators.

A normally open Guardian contact is physically molded and wired in series with a standard set of normally closed (NC) contacts. The normally open Guardian contacts automatically close when the contact block is properly installed on the E-Stop operator ❶. In this state, the E-Stop and NC contacts operate as usual, with actuation of the E-Stop causing the NC contacts to open ❷.

If the contact block should separate from the E-Stop operator, the normally open Guardian contacts will automatically open ❸. Because the Guardian contacts are wired in series with the NC contacts, the opening of either set of contacts will open the circuit being controlled by the E-Stop.

	❶ Normal Operation	❷ Actuated Button	❸ Improperly Installed
	X	X	0
	X	0	X
	X	0	0

- ❶ Not available with inscriptions. Order inscription ring or legend plate for identification. See pages H6:6 and H6:11 for information.
- ❷ Up to 6 contact blocks (3 across / 2 high) can be attached. Up to 4 contact blocks for the Guardian block
- ❸ For Ronis replacement keys, see Accessories page H6:8.

Two Position Operators, Twist-to-release, Illuminated (Complete Kits) ③④⑥

Contact Block(s) ①②	Plastic operator with plastic bezel		Metal operator with metal bezel	
	40mm Mushroom ③	60mm Mushroom ③	40mm Mushroom ③	60mm Mushroom ③
	Catalog Number	Catalog Number	Catalog Number	Catalog Number
Oper. Only	D7P-LMT44	D7P-LMT64	D7M-LMT44	D7M-LMT64
Integral LED Module				
1NO	D7P-LMT44P♣X10	D7P-LMT64P♣X10	D7M-LMT44P♣X10	D7M-LMT64P♣X10
1NC	D7P-LMT44P♣X01	D7P-LMT64P♣X01	D7M-LMT44P♣X01	D7M-LMT64P♣X01
GCB	D7P-LMT44P♣X01S	D7P-LMT64P♣X01S	D7M-LMT44P♣X01S	D7M-LMT64P♣X01S
2NO	D7P-LMT44P♣X20	D7P-LMT64P♣X20	D7M-LMT44P♣X20	D7M-LMT64P♣X20
2NC	D7P-LMT44P♣X02	D7P-LMT64P♣X02	D7M-LMT44P♣X02	D7M-LMT64P♣X02
1NO/1NC	D7P-LMT44P♣X11	D7P-LMT64P♣X11	D7M-LMT44P♣X11	D7M-LMT64P♣X11
3NO	D7P-LMT44P♣X30	D7P-LMT64P♣X30	D7M-LMT44P♣X30	D7M-LMT64P♣X30
3NC	D7P-LMT44P♣X03	D7P-LMT64P♣X03	D7M-LMT44P♣X03	D7M-LMT64P♣X03
2NO/1NC	D7P-LMT44P♣X21	D7P-LMT64P♣X21	D7M-LMT44P♣X21	D7M-LMT64P♣X21
1NO/2NC	D7P-LMT44P♣X12	D7P-LMT64P♣X12	D7M-LMT44P♣X12	D7M-LMT64P♣X12

H2

Complete Kit Ordering Instructions

D7P –	LMT4	4	P	♣	X10
Oper. Construction	Operator Type	Lens Cap Color	Mounting Latch	Power Module ④	Contacts ①②
D7P - Plastic operator with plastic bezel (Type 4/4X/13, IP66)	LMT4 - 2-position, 40mm mushroom, twist-to-release, illuminated	4 - Red	P - Plastic latch (D7P and D7M offered with plastic latch as standard)	Integral LED module N3R, 24V AC/DC N5R, 120V AC N7R, 240V AC	X10 - 1NO → X01 - 1NC X20 - 2NO X02 - 2NC X11 - 1NO/1NC
D7M - Metal operator with metal bezel (Type 4/13, IP66)	LMT6 - 2-position, 60mm mushroom, twist-to-release, illuminated		M - Metal latch List price changes		

→ Positive Opening per EN60947-5-1 (applies to all NC contact block styles)

- ① Up to 4 contact blocks can be attached.
- ② See page H6:12 for complete kit ordering information on other special contact blocks and power modules.
- ③ Not available with inscriptions. Order inscription ring or legend plate for identification. See pages H6:6 and H6:11 for information.
- ④ Integral LED module required for illumination, cannot use incandescent module.

- ⑤ Operators are EN-ISO13850 compliant with standard NC, NCLB or Guardian contact blocks.
- ⑥ Operators, latch, and contact block combinations have been third-party tested for B10d values. B10d values can be found in approval document EL660_01_10 online at www.sprecherschuh.com.

Two Position Operators, Twist-to-release, Illuminated (Components) ❶

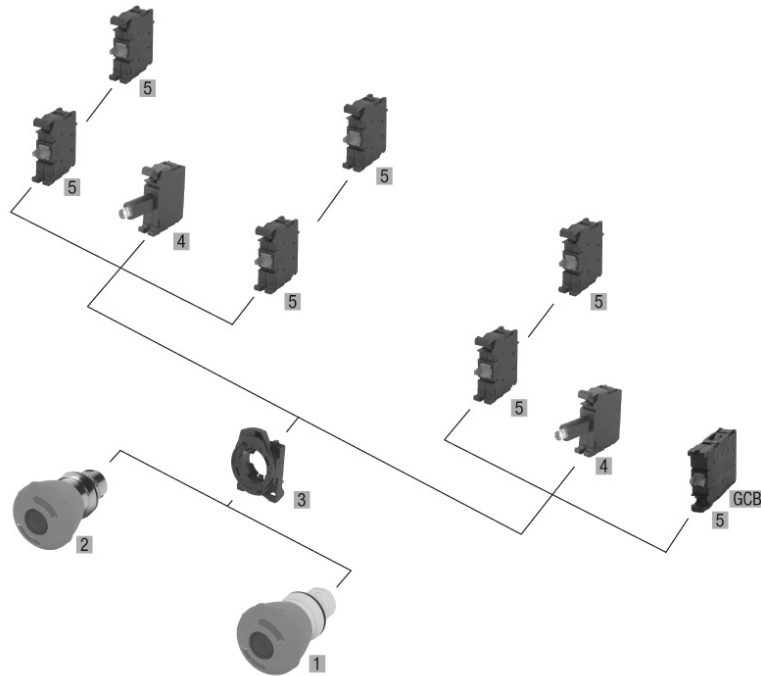

Component	Catalog Number	Pkg. Qty.
01 Plastic operator with plastic bezel, 2-position, 40mm twist-to-release, illuminated ❶❸ Red Plastic operator with plastic bezel, 2-position, 60mm twist-to-release, illuminated ❶❸ Red	D7P-LMT44 D7P-LMT64	1 1
02 Metal operator with metal bezel, 2-position, 40mm twist-to-release, illuminated ❶❸ Red Metal operator with metal bezel, 2-position, 60mm twist-to-release, illuminated ❶❸ Red	D7M-LMT44 D7M-LMT64	1 1
03 Tool-less Mounting Latch (for snap-on contact blocks and power modules) Plastic Latch Metal Latch	D7-ALP D7-ALM	10

Component	Catalog Number	Pkg. Qty.
04 Power Module, Integral LED RED 24V AC/DC RED 120V AC RED 240V AC	D7-N3R D7-N5R D7-N7R	10
05 Contact blocks ❷ NO NC NO, low voltage NC, low voltage GCB, Guardian Block	D7-X10 D7-X01 ⇄ D7-X10V ❹ D7-X01V ⇄ ❹ D7-X01S ⇄	10

⇄ Positive Opening per EN60947-5-1 (applies to all NC contact block styles)

- ❶ Not available with inscriptions. Order inscription ring or legend plate for identification. See pages H6:6 and H6:11 for information.
- ❷ Up to 4 contact blocks can be attached.
- ❸ Integral LED module required for illumination, cannot use incandescent module.
- ❹ Low voltage contact blocks must be ordered separately.

Two Position Selector Switches, Non-Illuminated (Complete Kits) ①



Switching Positions	Contact Block(s) ②③	Plastic operator with plastic bezel	Metal operator with metal bezel
		Catalog Number	Catalog Number
 M2	Oper. Only	D7P-♣M22	D7M-♣M22
	1	D7P-♣M22P▼	D7M-♣M22P▼
	2	D7P-♣M22P▼	D7M-♣M22P▼
 L2	Oper. Only	D7P-♣L22	D7M-♣L22
	1	D7P-♣L22P▼	D7M-♣L22P▼
	2	D7P-♣L22P▼	D7M-♣L22P▼
 R2	Oper. Only	D7P-♣R22	D7M-♣R22
	1	D7P-♣R22P▼	D7M-♣R22P▼
	2	D7P-♣R22P▼	D7M-♣R22P▼

H3

Complete Kit Ordering Instructions ④

D7P –	♣	M2	2	P	▼
Oper. Construction D7P - Plastic operator with plastic bezel (Type 4/4X/13, IP66) D7M - Metal operator with metal bezel (Type 4/13, IP66)	Operator Type S - Standard knob H - Long knob ⑤ List price changes	Oper. Function M2 - Maintained, 60° switching angle L2 - Spring return from left, 60° R2 - Spring return from right, 60°	Knob Color 2 - Black knob, white insert	Mounting Latch P - Plastic latch (D7P and D7M offered with plastic latch as standard) M - Metal latch List price changes	Contacts ②③ X10 - 1NO X01 - 1NC X20 - 2NO X02 - 2NC X11 - 1NO/1NC

↻ Positive Opening per EN60947-5-1 (applies to all NC contact block styles)

Contact Type	Mounting Position on Latch		
NO	All slots	O	X
NC	All slots	X	O

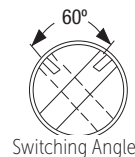

- ① Legend plates sold separately. See page H6:11 for information.
- ② Up to 6 contact blocks (3 across / 2 high) can be attached.
- ③ See page H6:7 for complete kit ordering information on other special contact blocks: Early make, late break, low voltage contact blocks.
- ④ Contact actuation is reversed for "L2" type switch.
- ⑤ 30mm hole spacing will not work if long knob lever is used. See page H7:6 for recommended operator panel spacing.

Two Position Selector Switches, Non-Illuminated (Components) ❶

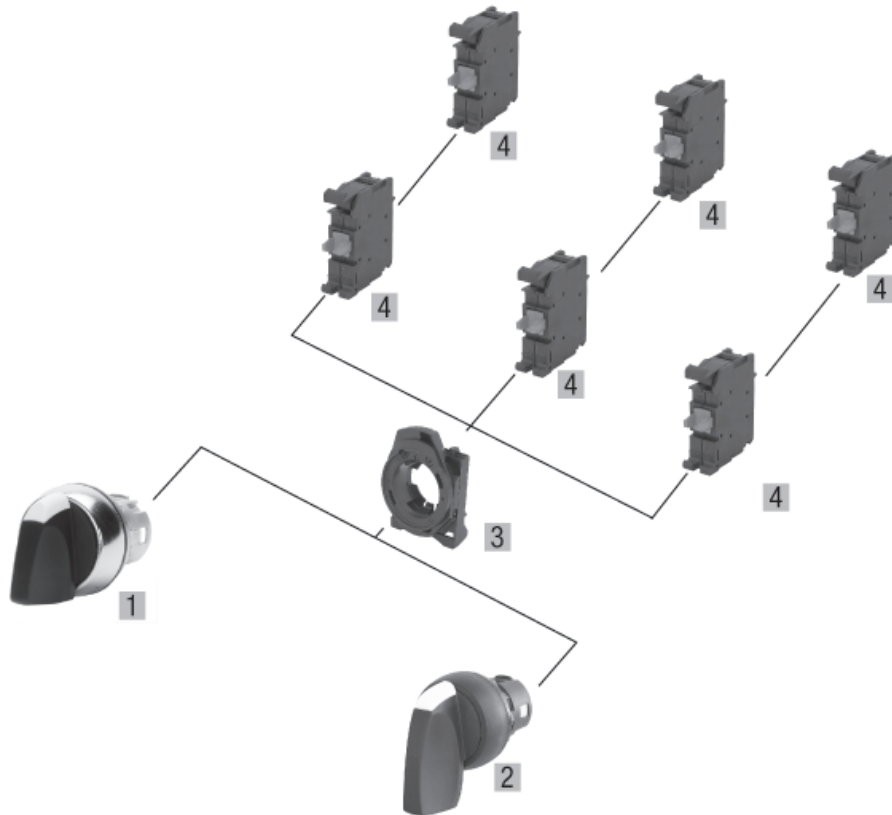

Component	Catalog Number	Pkg. Qty.
01 Standard knob, plastic operator, front bezel ❸		
Maintained 60° Black	D7P-SM22	1
Spring return from left, 60° Black	D7P-SL22	
Spring return from right, 60° Black	D7P-SR22	
Standard knob, shiny metal operator, front bezel ❸		
Maintained 60° Black	D7M-SM22	1
Spring return from left, 60° Black	D7M-SL22	
Spring return from right, 60° Black	D7M-SR22	
02 Long knob, plastic operator, front bezel		
Maintained 60° Black	D7P-HM22	1
Spring return from left, 60° Black	D7P-HL22	
Spring return from right, 60° Black	D7P-HR22	
Long knob, shiny metal operator, front bezel		
Maintained 60° Black	D7M-HM22	1
Spring return from left, 60° Black	D7M-HL22	
Spring return from right, 60° Black	D7M-HR22	

Component	Catalog Number	Pkg. Qty.
03 Tool-less Mounting Latch (for snap-on contact blocks and power modules)		
Plastic Latch	D7-ALP	10
Metal Latch	D7-ALM	
04 Contact blocks ❷		
NO	D7-X10	10
NC	D7-X01	
NO, low voltage	D7-X10V ❹	
NC, low voltage	D7-X01V ❹	

❶ Legend plates sold separately. See page H6:11 for information.

❷ Up to 6 contact blocks (3 across / 2 high) can be attached.

❸ 90° offset knob operators for vertical mount enclosure are available. Add the "N" designation to selected operator part number. Example, D7P-SM22N.

❹ Low voltage contact blocks must be ordered separately.

Three Position Selector Switches, Non-Illuminated (Complete Kits) ①

Switching Positions	Contact Block(s) ②③	Plastic operator with plastic bezel	Metal operator with metal bezel
		Catalog Number	Catalog Number
M3 	Oper. Only	D7P-♣M32	D7M-♣M32
	2	D7P-♣M32P▼	D7M-♣M32P▼
	3	D7P-♣M32P▼	D7M-♣M32P▼
L3 	Oper. Only	D7P-♣L32	D7M-♣L32
	2	D7P-♣L32P▼	D7M-♣L32P▼
	3	D7P-♣L32P▼	D7M-♣L32P▼
R3 	Oper. Only	D7P-♣R32	D7M-♣R32
	2	D7P-♣R32P▼	D7M-♣R32P▼
	3	D7P-♣R32P▼	D7M-♣R32P▼
B3 	Oper. Only	D7P-♣B32	D7M-♣B32
	2	D7P-♣B32P▼	D7M-♣B32P▼
	3	D7P-♣B32P▼	D7M-♣B32P▼

Complete Kit Ordering Instructions

D7P –	♣	M3	2	P	▼
Oper. Construction D7P - Plastic operator with plastic bezel (Type 4/4X/13, IP66) D7M - Metal operator with metal bezel (Type 4/13, IP66)	Operator Type S - Standard knob H - Long knob ④ List price changes	Oper. Function M3 - Maintained, 60° switching angle L3 - Spring return from left, 60° R3 - Spring return from right, 60° B3 - Spring return from left and right, 60°	Knob Color 2 - Black knob, white insert	Mounting Latch P - Plastic latch (D7P and D7M offered with plastic latch as standard) M - Metal latch List price changes	Contacts ②③ X10 - 1NO X01 - 1NC → X20 - 2NO X02 - 2NC X11 - 1NO/1NC X30 - 3NO X03 - 3NC X21 - 2NO/1NC X12 - 1NO/2NC

→ Positive Opening per EN60947-5-1 (applies to all NC contact block styles)

Contact Development Table

Contact Type	Mounting Position on Latch			
NO	Left (slot 1)	X	O	O
NO	Center (slot 3)	X	O	X
NO	Right (slot 2)	O	O	X
NC	Left (slot 1)	O	X	X
NC	Center (slot 3)	O	X	O
NC	Right (slot 2)	X	X	O
Special Center Activation ⑤				
NO	Center CL	X	O	O
NO	Center CR	O	O	X
NC	Center CL	O	X	X
NC	Center CR	X	X	O

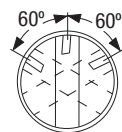

Switching Angle

① Legend plates sold separately. See page H6:11 for information.

② Up to 6 contact blocks (3 across / 2 high) can be attached.

③ See page H6:7 for complete kit ordering information on other special contact blocks: Early make, late break, low voltage contact blocks.

④ 30mm hole spacing will not work if long knob lever is used. See page H7:6 for recommended operator panel spacing.

⑤ Standard operators not available for Center position activation (CL/CR). Modification can be field installed with accessory item D7-ACP for center position activation. See Accessory page H6:5 to order.

Three Position Selector Switches, Non-Illuminated (Components) ❶

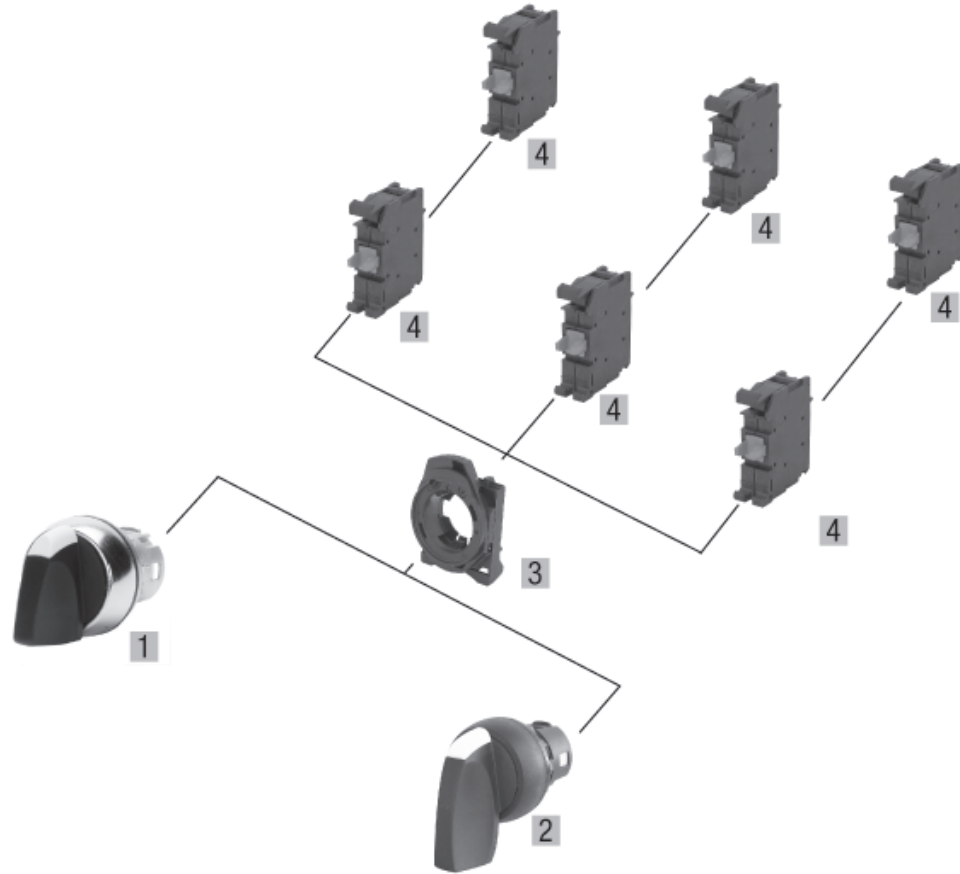



Component	Catalog Number	Pkg. Qty.
01 Standard knob, plastic front bezel ❸		
Maintained 60°	Black D7P-SM32	1
Spring return from left, 60°	Black D7P-SL32	
Spring return from right, 60°	Black D7P-SR32	
Spring return from left and right, 60°	Black D7P-SB32	
Standard knob, shiny metal front bezel ❸		
Maintained 60°	Black D7M-SM32	1
Spring return from left, 60°	Black D7M-SL32	
Spring return from right, 60°	Black D7M-SR32	
Spring return from left and right, 60°	Black D7M-SB32	
02 Long knob, plastic front bezel		
Maintained 60°	Black D7P-HM32	1
Spring return from left, 60°	Black D7P-HL32	
Spring return from right, 60°	Black D7P-HR32	
Spring return from left and right, 60°	Black D7P-HB32	
Long knob, shiny metal front bezel		
Maintained 60°	Black D7M-HM32	1
Spring return from left, 60°	Black D7M-HL32	
Spring return from right, 60°	Black D7M-HR32	
Spring return from left and right, 60°	Black D7M-HB32	

Component	Catalog Number	Pkg. Qty.
03 Tool-less Mounting Latch (for snap-on contact blocks and power modules)		
Plastic Latch	D7-ALP	10
Metal Latch	D7-ALM	
04 Contact blocks ❷		
NO	D7-X10	10
NC	D7-X01	
NO, low voltage	D7-X10V ❹	
NC, low voltage	D7-X01V ❹	

- ❶ Legend plates sold separately. See page H6:11 for information.
- ❷ Up to 6 contact blocks (3 across / 2 high) can be attached.
- ❸ 90° offset knob operators for vertical mount enclosure are available. Add the "N" designation to selected operator part number. Example, D7P-SM32N.
- ❹ Low voltage contact blocks must be ordered separately.





Four Position Selector Switches, Non-Illuminated (Operator Only) ①

Switching Positions	Plastic operator with plastic bezel	Metal operator with metal bezel
		
	Catalog Number	Catalog Number
	D7P-SM42	D7M-SM42

Important Note: Cannot use N.C. or N.O.E.M contact blocks with 4-position selector switch. Contact blocks and mounting latches sold separately, see next page to order.

Ordering Instructions (Operator Only)

D7P	-	S	M4	2
Oper. Construction	Operator Type	Oper. Function	Knob Color	
D7P - Plastic operator with plastic bezel (Type 4/4X/13, IP66)	S - Standard knob H - Long knob ⑤ List price changes	M4 - Maintained 45° switching angle	2 - Black knob white insert	
D7M - Metal operator with metal bezel (Type 4/13, IP66)				

Target Table and Operator Positions ②③						
Contact Type	Catalog Number	Position on Mounting Latch				
N.O.	D7-X10	Left	O	O	X	O
		Right	X	O	O	O
		Center	X	O	X	O
N.C.E.B.	D7-X01B	Left	O	O	O	X
		Right	O	X	O	O
N.C.L.B.	D7-X01L	Left	X	X	O	X
		Right	O	X	X	X
		Center	O	X	O	X
Special Center Activation ④						
N.O.	D7-X10	Center CL	O	O	X	O
		Center CR	X	O	O	O
N.C.E.B.	D7-X01B	Center CL	O	O	O	X
		Center CR	O	X	O	O
N.C.L.B.	D7-X01L	Center CL	X	X	O	X
		Center CR	O	X	X	X

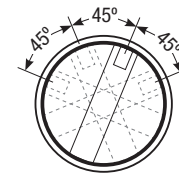

Switching Angle

Note: X = Closed/O = Open

- ① Legend plates sold separately. See page H6:11 for information.
- ② Up to 6 contact blocks (3 across / 2 high) can be attached.
- ③ Cannot use N.C. or N.O.E.M contact blocks with 4-position selector switch. Must use N.O., N.C.E.B., or N.C.L.B. contact blocks. Contact blocks and mounting latches sold separately, see next page to order.

- ④ Standard operators not available for Center position activation (CL/CR). Modification can be field installed with accessory item D7-ACP for center position activation. See accessory page H6:5 to order.
- ⑤ 30mm hole spacing will not work if long knob lever is used. See page H7:6 for recommended operator panel spacing.



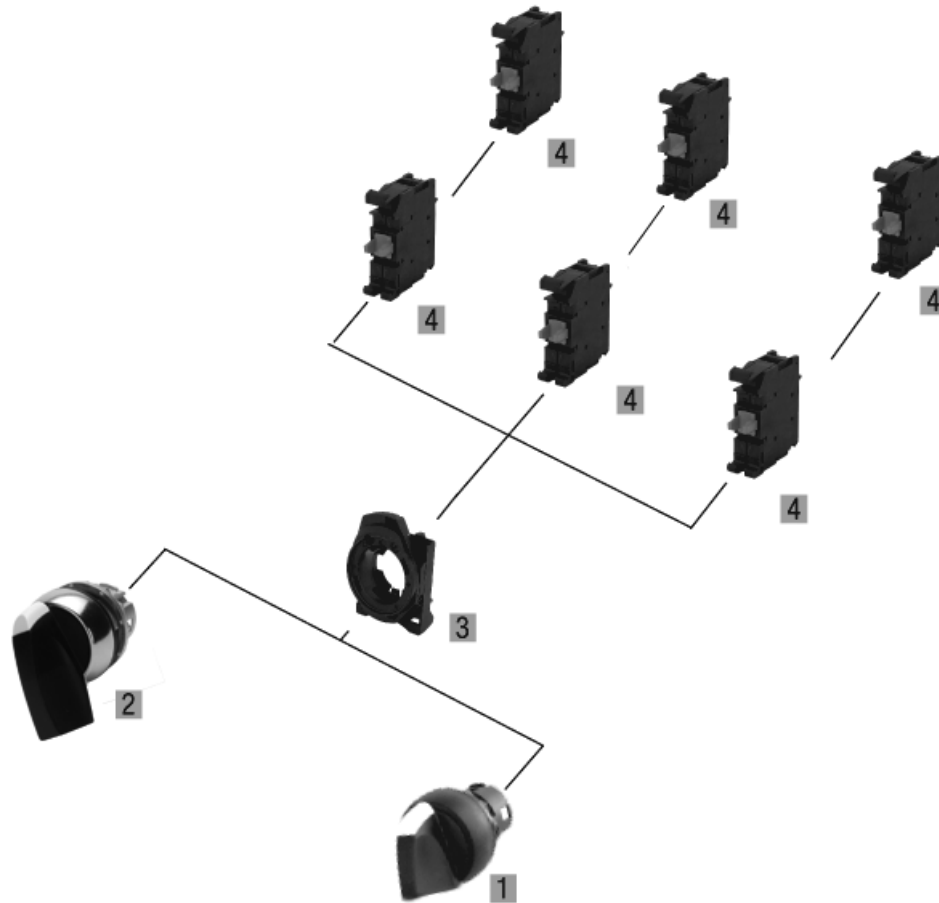

Four Position Selector Switches, Non-Illuminated (Components) ❶



Component	Catalog Number	Pkg. Qty.
01 Standard Knob, plastic front bezel ❶ Maintained	Black D7P-SM42	1
Standard Knob, metal front bezel ❶ Maintained	Black D7M-SM42	
02 Long Knob, plastic front bezel ❶ Maintained	Black D7P-HM42	1
Long Knob, metal front bezel ❶ Maintained	Black D7M-HM42	
03 Tool-less Mounting Latch (for snap-on contact blocks and power modules)	Plastic Latch Metal Latch D7-ALP D7-ALM	10
04 Contact blocks ❷❸	NO NC late break (N.C.L.B.) D7-X10 D7-X01L	
	NC early break (N.C.E.B.) D7-X01B	

- ❶ Legend plates sold separately. See page H6:11 for order information.
- ❷ Up to 6 contact blocks (3 across / 2 high) can be attached.
- ❸ Cannot use N.C. or N.O.E.M contact blocks with 4-position selector switch.



Two Position Selector Switches, Illuminated (Complete Kits) ①⑤⑦

Switching Positions	Contact Block(s) ②③	Power Module Type	Plastic operator with plastic bezel	Metal operator with metal bezel
				
			Catalog Number	Catalog Number
M2 	Oper. Only	Oper. Only	D7P-LSM2④	D7M-LSM2④
	1	LED Integral	D7P-LSM2④P⑤⑥▼	D7M-LSM2④P⑤⑥▼
	2	LED Integral	D7P-LSM2④P⑤⑥▼	D7M-LSM2④P⑤⑥▼
L2 	Oper. Only	Oper. Only	D7P-LSL2④	D7M-LSL2④
	1	LED Integral	D7P-LSL2④P⑤⑥▼	D7M-LSL2④P⑤⑥▼
	2	LED Integral	D7P-LSL2④P⑤⑥▼	D7M-LSL2④P⑤⑥▼
R2 	Oper. Only	Oper. Only	D7P-LSR2④	D7M-LSR2④
	1	LED Integral	D7P-LSR2④P⑤⑥▼	D7M-LSR2④P⑤⑥▼
	2	LED Integral	D7P-LSR2④P⑤⑥▼	D7M-LSR2④P⑤⑥▼

Complete Kit Ordering Instructions

D7P –	LS	M2	★	P	♣	▼
Oper. Construction D7P - Plastic operator with plastic bezel (Type 4/4X/13, IP66) D7M - Metal operator with metal bezel (Type 4/13, IP66)	Operator Type LS - Standard knob LH - Long knob ③③	Oper. Function M2 - Maintained, 60° switching angle L2 - Spring return from left, 60° R2 - Spring return from right, 60°	Knob Color 0 - Amber/White insert 3 - Green/White insert 4 - Red/White insert 5 - Yellow/Black insert 6 - Blue/White insert 7 - Clear/Black insert	Mounting Latch P - Plastic latch (D7P and D7M offered with plastic latch as standard) M - Metal latch <i>List price changes</i>	Power Module <i>Integral LED module</i> N3x, 24V AC/DC N5x, 120V AC N7x, 240V AC	Contacts ②③ X10 - 1NO X01 - 1NC → X20 - 2NO X02 - 2NC X11 - 1NO/1NC

→ Positive Opening per EN60947-5-1 (applies to all NC contact block styles)

Contact Type	Mounting Position on Latch		
NO ④	All slots	O	X
NC ④	All slots	X	O

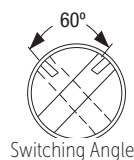

For lens color...	replace "x" with...
Green	G
Red	R
Amber Yellow Blue Clear	W

- ① Legend plates sold separately. See page H6:11 for order information.
- ② Up to 4 contact blocks can be attached.
- ③ See page H6:7 for complete kit ordering information on other special contact blocks and power modules.
- ④ Contact actuation is reversed for "L2" type switch.
- ⑤ LED Module required for illumination, cannot use incandescent module.

- ⑥ Only available in clear knob color.
- ⑦ Crevices may exist on product that may be unsuitable for certain applications. Please consult your Sprecher + Schuh representative.
- ⑧ 30mm hole spacing will not work if long knob lever is used. See page H7:6 for recommended operator panel spacing.

Two Position Selector Switches, Illuminated (Components) ❶

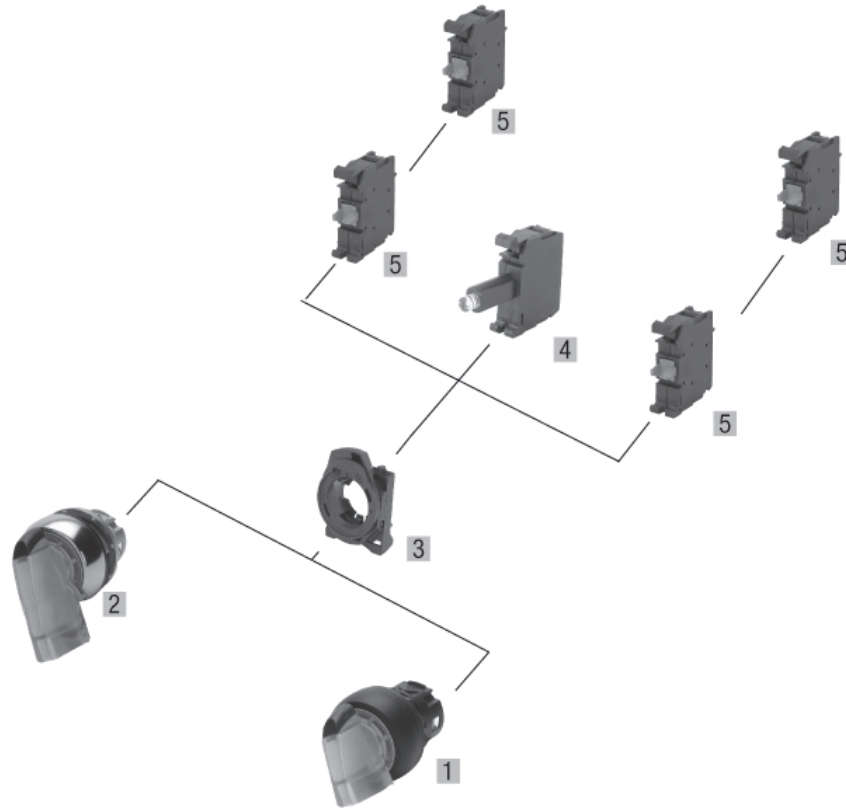

Component	Catalog Number	Pkg. Qty.
01 Standard knob, plastic front bezel ❸❹ Maintained 60° Spring return from left, 60° Spring return from right, 60°	D7P-LSM2z D7P-LSL2z D7P-LSR2z	1
Standard knob, metal front bezel ❸❹ Maintained 60° Spring return from left, 60° Spring return from right, 60°	D7M-LSM2z D7M-LSL2z D7M-LSR2z	
02 Long knob, plastic front bezel Maintained 60° Clear Spring return from left 60° Clear Spring return from right 60° Clear	D7P-LHM27 D7P-LHL27 D7P-LHR27	1
Long knob, metal front bezel Maintained 60° Clear	D7M-LHM27	
Spring return from left 60° Clear Spring return from right 60° Clear	D7M-LHL27 D7M-LHR27	

Component	Catalog Number	Pkg. Qty.
03 Tool-less Mounting Latch (for snap-on contact blocks and power modules) Plastic Latch Metal Latch	D7-ALP D7-ALM	10
04 Power Module, Integral LED ❹ 24V AC/DC 120V AC 240V AC	D7-N3x D7-N5x D7-N7x	10
05 Contact blocks ❷ NO NC NO, low voltage NC, low voltage	D7-X10 D7-X01 D7-X10V ❺ D7-X01V ❺	10

- ❶ Legend plates sold separately. See page H6:11 for order information.
- ❷ Up to 4 contact blocks can be attached.
- ❸ 90° offset knob operators for vertical mount enclosure are available. Add the "N" designation to selected operator part number. Example, D7P-SM22N.
- ❹ To complete the catalog no., replace the x with one of the codes on the previous page.
- ❺ To complete the catalog no., replace the z with one of the following letters for desired color: 0 = Amber, 3 = Green, 4 = Red, 5 = Yellow, 6 = Blue, 7 = Clear.
LED Module required for illumination, cannot use incandescent module.
- ❻ Low voltage contact blocks must be ordered separately.

Three Position Selector Switches, Illuminated (Complete Kits) ①④⑤





Switching Positions	Contact Block(s) ②③	Lamp Element Type	Plastic operator with plastic bezel	Metal operator with metal bezel
				
			Catalog Number	Catalog Number
 M3	Oper. Only	Oper. Only	D7P-LSM3 ③	D7M-LSM3 ③
	2	LED Integral	D7P-LSM3 ③P♣▼	D7M-LSM3 ③P♣▼
 L3	Oper. Only	Oper. Only	D7P-LSL3 ③	D7M-LSL3 ③
	2	LED Integral	D7P-LSL3 ③P♣▼	D7M-LSL3 ③P♣▼
 R3	Oper. Only	Oper. Only	D7P-LSR3 ③	D7M-LSR3 ③
	2	LED Integral	D7P-LSR3 ③P♣▼	D7M-LSR3 ③P♣▼
 B3	Oper. Only	Oper. Only	D7P-LSB3 ③	D7M-LSB3 ③
	2	LED Integral	D7P-LSB3 ③P♣▼	D7M-LSB3 ③P♣▼

H3
D7 Pilot Devices

Complete Kit Ordering Instructions

D7P –	LS	M3	★	P	♣	▼
Oper. Construction D7P - Plastic operator with plastic bezel (Type 4/4X/13, IP66) D7M - Metal operator with metal bezel (Type 4/13, IP66)	Operator Type LS - Standard knob LH - Long knob ⑥⑦ list price changes	Oper. Function M3 - Maintained, 60° switching angle L3 - Spring return from left, 60° R3 - Spring return from right, 60° B3 - Spring return from left and right, 60°	Knob Color 0 - Amber/White insert 3 - Green/White insert 4 - Red/White insert 5 - Yellow/Black insert 6 - Blue/White insert 7 - Clear/Black insert	Mounting Latch P - Plastic latch (D7P and D7M offered with plastic latch as standard) M - Metal latch List price changes	Power Module <i>Integral LED module</i> N3x, 24V AC/DC N5x, 120V AC N7x, 240V AC	Contacts ②③ X20 - 2NO X02 - 2NC (→) X11 - 1NO/NC

(→) Positive Opening per EN60947-5-1 (applies to all NC contact block styles)

Contact Type	Mounting Position on Latch				
NO	Left (slot 1)	X	O	O	O
NO	Right (slot 2)	O	O	O	X
NC	Left (slot 1)	O	X	X	X
NC	Right (slot 2)	X	X	X	O

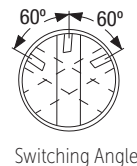

For lens color...	replace "x" with...
Green	G
Red	R
Amber Yellow Blue Clear	W

- ① Legend plates sold separately. See page H6:11 for information.
- ② Up to 4 contact blocks can be attached.
- ③ See page H6:7 for complete kit ordering information on other special contact blocks and power modules.
- ④ LED Module required for illumination, cannot use incandescent module.

- ⑤ Cracks may exist on product that may be unsuitable for certain applications. Please consult your Sprecher + Schuh representative.
- ⑥ Available in Clear/Black knob color only.
- ⑦ 30mm hole spacing will not work if long knob lever is used. See page H7:6 for recommended operator panel spacing.

Three Position Selector Switches, Illuminated (Components) ❶

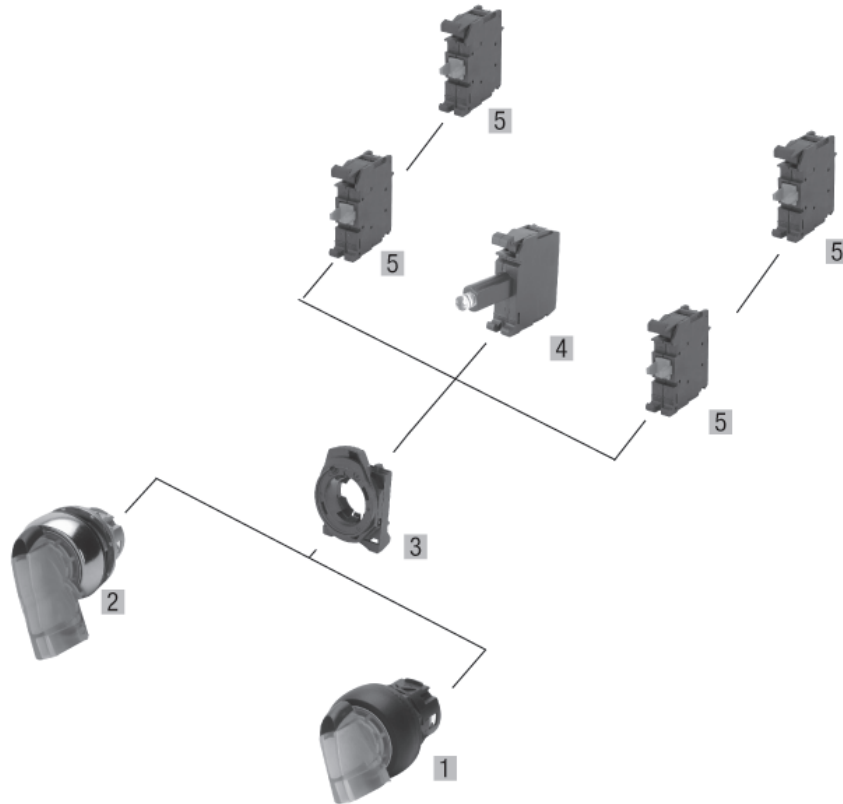

Component	Catalog Number	Pkg. Qty.
01 Standard knob, plastic front bezel ❸❹ Maintained 60° Spring return from left, 60° Spring return from right, 60° Spring return from left and right, 60° Standard knob, metal front bezel ❸❹ Maintained 60° Spring return from left, 60° Spring return from right, 60° Spring return from left and right, 60°	D7P-LSM3z D7P-LSL3z D7P-LSR3z D7P-LSB3z D7M-LSM3z D7M-LSL3z D7M-LSR3z D7M-LSB3z	1 1
02 Long knob, plastic front bezel Maintained 60° Spring return from left, 60° Spring return from right, 60° Spring return from left and right, 60° Long knob, metal front bezel Maintained 60° Spring return from left, 60° Spring return from right, 60° Spring return from left and right, 60°	Clear Clear Clear Clear Clear Clear Clear Clear	D7P-LHM37 D7P-LHL37 D7P-LHR37 D7P-LHB37 D7M-LHM37 D7M-LHL37 D7M-LHR37 D7M-LHB37

Component	Catalog Number	Pkg. Qty.
03 Tool-less Mounting Latch (for snap-on contact blocks and power modules) Plastic Latch Metal Latch	D7-ALP D7-ALM	10
04 Power Module, Integral LED ❶ 24V AC/DC 120V AC 240V AC	D7-N3x D7-N5x D7-N7x	10
05 Contact blocks ❷ NO NC NO, early make NC, late break NO, low voltage NC, low voltage	D7-X10 D7-X01 D7-X10E D7-X01L D7-X10V D7-X01V	10

- ❶ Legend plates sold separately. See page H6:11 for information.
- ❷ Up to 4 contact blocks can be attached.
- ❸ 90° offset knob operators for vertical mount enclosure are available. Add the "N" designation to selected operator part number. Example, D7P-SM32N.
- ❹ To complete the catalog no., replace the x with one of the codes on the previous page.
- ❺ To complete the catalog no., replace the z with one of the following letters for desired color: 0 = Amber, 3 = Green, 4 = Red, 5 = Yellow, 6 = Blue, 7 = Clear.
LED Module required for illumination, cannot use incandescent module.

Two Position Key Operated Selector Switches (Complete Kits) ①②

Switching Positions	Contact Block(s) ③④	Plastic operator with plastic bezel	Metal operator with metal bezel
		Catalog Number	Catalog Number
 M2	Oper. Only	D7P-KM2	D7M-KM2
	1	D7P-KM2 P	D7M-KM2 P
	2	D7P-KM2 P	D7M-KM2 P
 L2	Oper. Only	D7P-KL2	D7M-KL2
	1	D7P-KL2 P	D7M-KL2 P
	2	D7P-KL2 P	D7M-KL2 P
 R2	Oper. Only	D7P-KR2	D7M-KR2
	1	D7P-KR2 P	D7M-KR2 P
	2	D7P-KR2 P	D7M-KR2 P

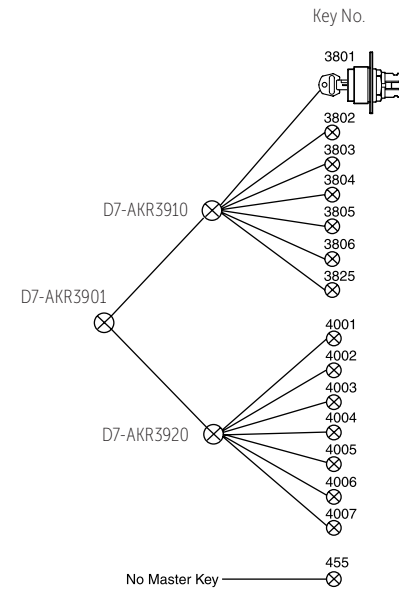

Complete Kit Ordering Instructions

D7P –	KM2	★	♣	P	▼
Oper. Construction D7P - Plastic operator with plastic bezel (Type 4/13, IP66) D7M - Metal operator with metal bezel (Type 4/13, IP66)	Operator Type KM2 - Maintained, 60° switching angle, "Ronis" lock KL2 - Spring return from left, 60°, "Ronis" lock KR2 - Spring return from right, 60°, "Ronis" lock	Key Removal 1 - Left 2 - Right 3 - Both 2 - Right 1 - Left	Key Code <i>Omit this position for a standard key (3825)</i> Ronis Key Lock Key Code Key No. Blank 3825 (Standard) R 455 01R 3801 02R 3802 03R 3803 04R 3804 05R 3805 06R 3806 27R 4001 28R 4002 29R 4003 30R 4004 31R 4005 32R 4006 33R 4007	Mounting Latch P - Plastic latch (D7P and D7M offered with plastic latch as standard) M - Metal latch <i>List price change</i>	Contacts X10 - 1NO X01 - 1NC X20 - 2NO X02 - 2NC X11 - 1NO/1NC

Contact Type	Mounting Position on Latch		
NO	All slots	O	X
NC	All slots	X	O

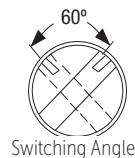

Positive Opening per EN60947-5-1 (applies to all NC contact block styles)

- ① Legend plates sold separately. See page H6:11 for information.
- ② Not intended for high security applications. Interoperability is possible with certain key/cylinder lock combinations.
- ③ Up to 6 contact blocks (3 across / 2 high) can be attached.

- ④ See page H6:7 for complete kit ordering information on other special contact blocks: Early make, late break, low voltage contact blocks.
- ⑤ Key removal from maintained position only.
- ⑥ Contact actuation is reversed for "L2" type switch.

Two Position Key Operated Selector Switches (Components) ❶

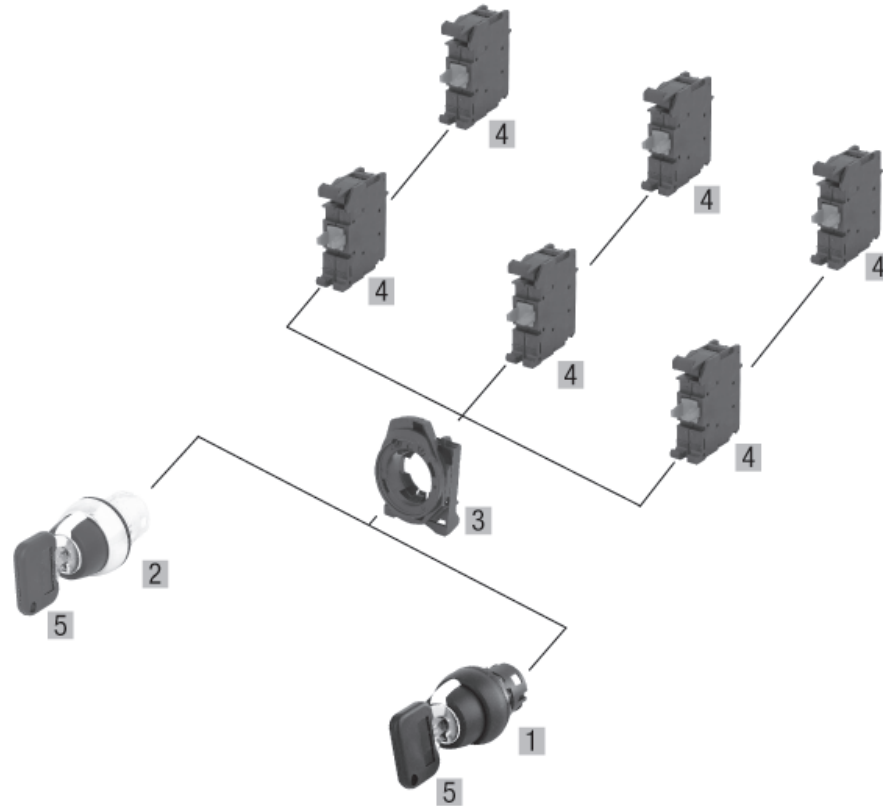

Component	Catalog Number	Pkg. Qty.
01 Plastic operator with plastic bezel, keyed, "Ronis" lock Maintained 60° Spring return from left, 60° Spring return from right, 60°	D7P-KM2 D7P-KL2 D7P-KR2	1
02 Standard knob, shiny metal front bezel, keyed, "Ronis" lock Maintained 60° Spring return from left, 60° Spring return from right, 60°	D7M-KM2 D7M-KL2 D7M-KR2	1
03 Tool-less Mounting Latch (for snap-on contact blocks and power modules) Plastic Latch Metal Latch	D7-ALP D7-ALM	10
04 Contact blocks ❷ NO NC NO, low voltage NC, low voltage	D7-X10 D7-X01 D7-X10V D7-X01V	10

Component	Catalog Number	Pkg. Qty.
05 Replacement Keys ❸ Ronis 3825 (standard key) Ronis 455 Ronis 3801 Ronis 3802 Ronis 3803 Ronis 3804 Ronis 3805 Ronis 3806 Ronis 4001 Ronis 4002 Ronis 4003 Ronis 4004 Ronis 4005 Ronis 4006 Ronis 4007 Ronis 3901 Ronis 3910 Ronis 3920	D7-AKR3825 D7-AKR455 D7-AKR3801 D7-AKR3802 D7-AKR3803 D7-AKR3804 D7-AKR3805 D7-AKR3806 D7-AKR4001 D7-AKR4002 D7-AKR4003 D7-AKR4004 D7-AKR4005 D7-AKR4006 D7-AKR4007 D7-AKR3901 D7-AKR3910 D7-AKR3920	1 set
<i>Note: Minimum order quantity is one package of 2 keys.</i>		

See "Complete Assembly Ordering Instructions" chart on opposite page to determine "Key Removal" (🔑) and "Key Codes" (🔑) if applicable.

- ❶ Legend plates sold separately. See page H6:11 for information.
- ❷ Up to 6 contact blocks (3 across / 2 high) can be attached.
- ❸ Master keys. See diagram on previous page for master key system details.
- ❹ Minimum order quantity is one package of 2 keys.
- ❺ Low voltage contact blocks must be ordered separately.

Three Position Key Operated Selector Switches (Complete Kits) ①②

Switching Positions	Contact Block(s) ③④	Plastic operator with plastic bezel	Metal operator with metal bezel	
		Catalog Number	Catalog Number	
M3 	Oper. Only	D7P-KM3♣	D7M-KM3♣	
		2	D7P-KM3♣P▼	D7M-KM3♣P▼
		3	D7P-KM3♣P▼	D7M-KM3♣P▼
L3 	Oper. Only	D7P-KL3♣	D7M-KL3♣	
		2	D7P-KL3♣P▼	D7M-KL3♣P▼
		3	D7P-KL3♣P▼	D7M-KL3♣P▼
R3 	Oper. Only	D7P-KR3♣	D7M-KR3♣	
		2	D7P-KR3♣P▼	D7M-KR3♣P▼
		3	D7P-KR3♣P▼	D7M-KR3♣P▼
B3 	Oper. Only	D7P-KB3♣	D7M-KB3♣	
		2	D7P-KB3♣P▼	D7M-KB3♣P▼
		3	D7P-KB3♣P▼	D7M-KB3♣P▼

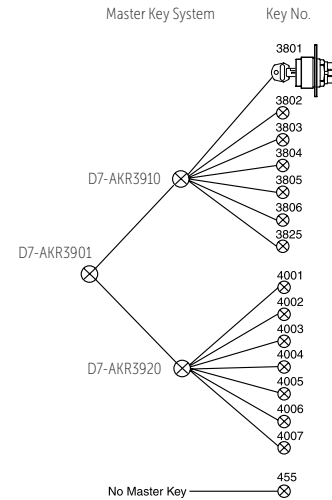

Complete Kit Ordering Instructions

D7P –	KM3	★	♣	P	▼	
Oper. Construction	Operator Type	Key Removal ⑥	Key Code		Mounting Latch	Contacts ③④
D7P - Plastic operator with plastic bezel (Type 4/4X/13, IP66)	KM3 - Maintained, 60° switching angle, "Ronis" lock	1 - Left 3 - All 4 - Center 5 - Left/Center 7 - Center/Right	Omit this position for a standard key (3825) Ronis Key Lock		P - Plastic latch (D7P and D7M offered with plastic latch as standard)	X20 - 2NO X02 - 2NC X11 - 1NO/1NC X30 - 3NO X03 - 3NC X21 - 2NO/1NC X12 - 1NO/2NC
D7M - Metal operator with metal bezel (Type 4/13, IP66)	KL3 - Spring return from left, 60° switching angle, "Ronis" lock	4 - Center 7 - Center/Right	Key Code	Key No.	M - Metal latch (List price change)	
	KR3 - Spring return from right, 60° switching angle, "Ronis" lock	1 - Left 4 - Center 5 - Left/Center	Blank	3825 (Standard)		
	KB3 - Spring return from left and right, 60° switching angle, "Ronis" lock	4 - Center	R	455		
			01R	3801		
			02R	3802		
			03R	3803		
			04R	3804		
			05R	3805		
			06R	3806		
			27R	4001		
			28R	4002		
			29R	4003		
			30R	4004		
			31R	4005		
			32R	4006		
			33R	4007		

➡ Positive Opening per EN60947-5-1 (applies to all NC contact block styles)

Contact Type	Mounting Position on Latch			
NO	Left (slot 1)	X	O	O
NO	Center (slot 3)	X	O	X
NO	Right (slot 2)	O	O	X
NC	Left (slot 1)	O	X	X
NC	Center (slot 3)	O	X	O
NC	Right (slot 2)	X	X	O

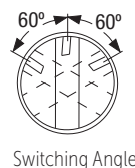

- ① Legend plates sold separately. See page H6:11 for information.
- ② Not intended for high security applications. Interoperability is possible with certain key/cylinder lock combinations interoperability information.

- ③ Up to 6 contact blocks (3 across / 2 high) can be attached.
- ④ See page H6:7 for complete kit ordering information on other special contact blocks: Early make, late break, low voltage contact blocks.
- ⑤ Key removal from maintained position only.
- ⑥ Contact actuation is reversed for "L3" type switch.

Three Position Key Operated Selector Switches (Components) ❶

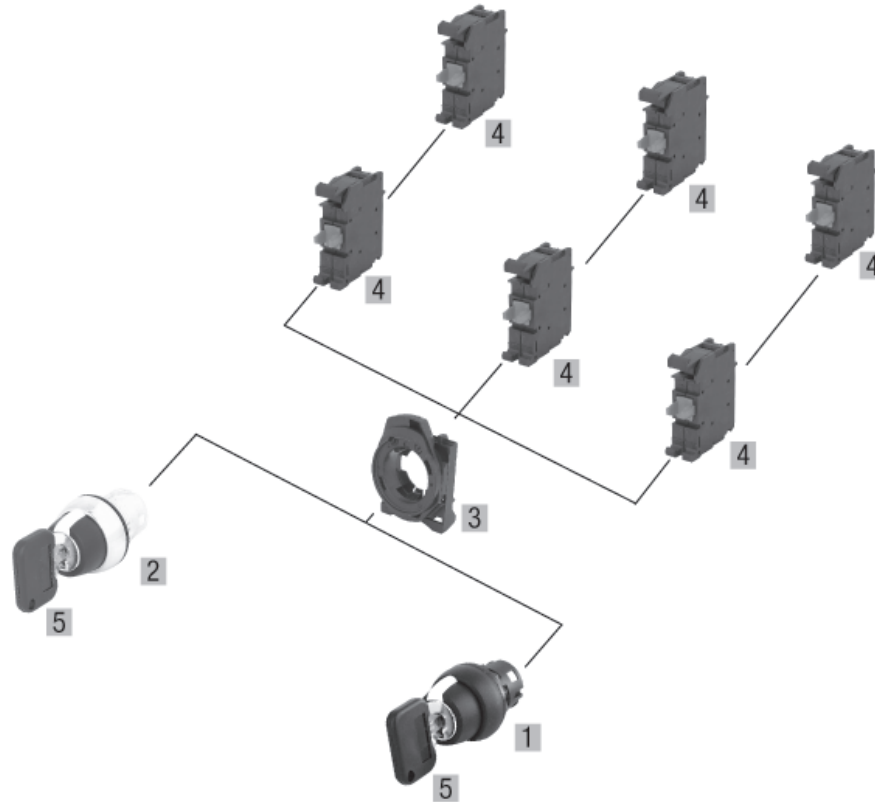

Component	Catalog Number	Pkg. Qty.
01 Plastic operator with plastic bezel, keyed, "Ronis" lock Maintained 60° Spring return from left, 60° Spring return from right, 60° Spring return from left and right, 60°	D7P-KM3 ❸❹ D7P-KL3 ❸❹ D7P-KR3 ❸❹ D7P-KB3 ❸❹	1
02 Standard knob, shiny metal front bezel, keyed, "Ronis" lock Maintained 60° Spring return from left, 60° Spring return from right, 60° Spring return from left and right, 60°	D7M-KM3 ❸❹❺ D7M-KL3 ❸❹❺ D7M-KR3 ❸❹❺ D7M-KB3 ❸❹❺	1
03 Tool-less Mounting Latch (for snap-on contact blocks and power modules) Plastic Latch Metal Latch	D7-ALP D7-ALM	10
04 Contact blocks ❷ NO NC NO, low voltage NC, low voltage	D7-X10 D7-X01 D7-X10V ❺ D7-X01V ❺	10

Component	Catalog Number	Pkg. Qty.
05 Replacement Keys ❹ Ronis 3825 (standard key) Ronis 455 Ronis 3801 Ronis 3802 Ronis 3803 Ronis 3804 Ronis 3805 Ronis 3806 Ronis 4001 Ronis 4002 Ronis 4003 Ronis 4004 Ronis 4005 Ronis 4006 Ronis 4007 Ronis 3901 ❸ Ronis 3910 ❸ Ronis 3920 ❸	D7-AKR3825 D7-AKR455 D7-AKR3801 D7-AKR3802 D7-AKR3803 D7-AKR3804 D7-AKR3805 D7-AKR3806 D7-AKR4001 D7-AKR4002 D7-AKR4003 D7-AKR4004 D7-AKR4005 D7-AKR4006 D7-AKR4007 D7-AKR3901 D7-AKR3910 D7-AKR3920	1 set

Note: Minimum order quantity is one package of 2 keys.

See "Complete Assembly Ordering Instructions" chart on opposite page to determine "Key Removal" (❸) and "Key Codes" (❹) if applicable.

- ❶ Legend plates sold separately. See page H6:11 for information.
- ❷ Up to 6 contact blocks (3 across / 2 high) can be attached.
- ❸ Master keys. See diagram on previous page for master key system details.
- ❹ Minimum order quantity is one package of 2 keys.
- ❺ Low voltage contact blocks must be ordered separately.

Multifunction Pushbuttons, Quick Order Guide (see following pages for Build Your Own part number matrix)

Two Position, Non-Illuminated									Plastic operator with plastic bezel		Metal operator with metal bezel	
Position A (Bottom)			Position C (Top)			Contacts		N.O.	N.C.	D7P-U2E4F3PX11	D7M-U2E4F3PX11	
Color	Type	Text	Color	Type	Text	Operator Only						
Red	Extended	Blank	Green	Flush	Blank	Operator Only		1	1	D7P-U2E4F3PX11	D7M-U2E4F3PX11	
		O			I	1	1	D7P-U2EFFEPX11	D7M-U2EFFEPX11			
		STOP			START	1	1	D7P-U2EBFAPX11	D7M-U2EBFAPX11			
Red	Extended	Blank	Green	Flush	Blank	Operator Only				D7P-U2E4F3	D7M-U2E4F3	
		O			I			D7P-U2EFFE	D7M-U2EFFE			
		STOP			START			D7P-U2EBFA	D7M-U2EBFA			

Three Position, Non-Illuminated											Plastic operator with plastic bezel		Metal operator with metal bezel	
Position A (Bottom)			Position B (Middle)			Position C (Top)			Contacts		N.O.	N.C.	D7P-U3F3F34PX21	D7M-U3F3F34PX21
Color	Type	Text	Color	Type	Text	Color	Type	Text	Operator Only					
Green	Flush	Blank	Red	Extended	Blank	Green	Flush	Blank	Operator Only		2	1	D7P-U3F3F34PX21	D7M-U3F3F34PX21
					Stop				2	1	D7P-U3F3F3BPX21	D7M-U3F3F3BPX21		
Green	Flush	Blank	Red	Extended	Blank	Operator Only						D7P-U3F3F34	D7M-U3F3F34	
					Stop					D7P-U3F3F3B	D7M-U3F3F3B			

Two Position, Illuminated									Plastic operator with plastic bezel		Metal operator with metal bezel	
Position A (Bottom)			Center	Position C (Top)			Contacts		N.O.	N.C.	D7P-LU2E4F3PN★WX11	D7M-LU2E4F3PN★WX11
Color	Type	Text	Type	Color	Type	Text	Operator Only					
Red	Extended	Blank	White Pilot Light	Green	Flush	Blank	Operator Only		1	1	D7P-LU2E4F3PN★WX11	D7M-LU2E4F3PN★WX11
		O				I	1	1	D7P-LU2EFFEPN★WX11	D7M-LU2EFFEPN★WX11		
		STOP				START	1	1	D7P-LU2EBFAPN★WX11	D7M-LU2EBFAPN★WX11		
Red	Extended	Blank	White Pilot Light	Green	Flush	Blank	Operator Only				D7P-LU2E4F3	D7M-LU2E4F3
		O				I			D7P-LU2EFFE	D7M-LU2EFFE		
		STOP				START			D7P-LU2EBFA	D7M-LU2EBFA		

Integral LED module
Replace ★ with

3	24V AC/DC
5	120V AC
7	240V AC

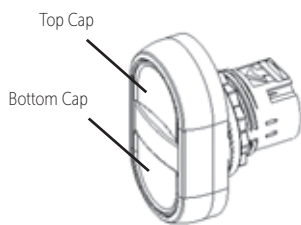

Two Position

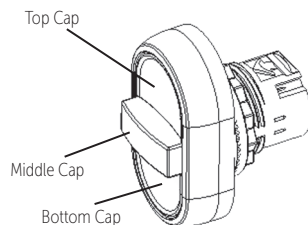

Three Position

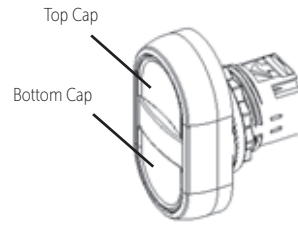

Two Position Illuminated

Multifunction Pushbutton Components Non-Illuminated ❶

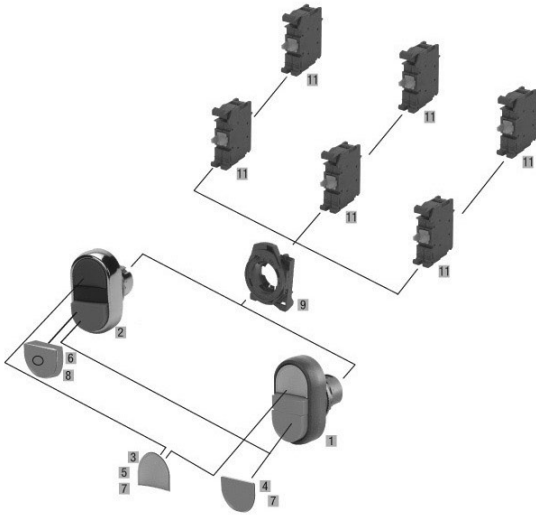

Illuminated ❶❷

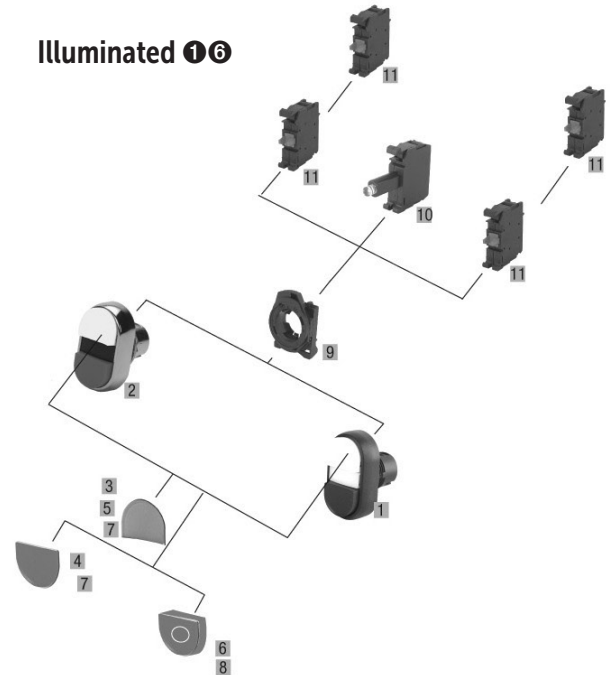

Component	Catalog Number	Pkg. Qty.	
01 Plastic operator with plastic bezel, two position, no color caps	D7P-U2X	1	
Metal operator with shiny metal bezel, two position, no color caps	D7M-U2X	1	
01 Plastic operator with plastic bezel, two position, illuminated, no color caps ❹	D7P-LU2X	1	
02 Plastic operator with plastic bezel, three position, extended red middle cap, no top and bottom color caps	D7P-U3X	1	
Metal operator with shiny metal bezel, three position, extended red middle cap, no top and bottom color caps	D7M-U3X	1	
Metal operator with shiny metal bezel, two position, illuminated, no color caps ❹	D7M-LU2X	1	
03 Top Color Caps, flush ❷ <i>Custom printed</i>	Green I White I Green II Green RIGHT Green UP Green FORWARD Green START White START	D7-AFCU3CU909 D7-AFCU1CU909 D7-AFCU3CU230 D7-AFCU3CE191 D7-AFCU3CE223 D7-AFCU3CE120 D7-AFCU3CE208 D7-AFCU1CE208	1
04 Bottom Color Caps, flush ❷ <i>Custom printed</i>	Green I White I Green II Green LEFT Green DOWN Green REVERSE Green START White START	D7-AFAU3CU909 D7-AFAU1CU909 D7-AFAU3CU230 D7-AFAU3CE145 D7-AFAU3CE110 D7-AFAU3CE188 D7-AFAU3CE208 D7-AFAU1CE208	1
05 Top Color Caps, extended ❷	Red STOP Black STOP Red O Black O	D7-AECU4CE212 D7-AECU2CE212 D7-AECU4CU910 D7-AECU2CU910	1

Component	Catalog Number	Pkg. Qty.	
06 Bottom Color Caps, extended ❷	Red STOP Black STOP Red O Black O	D7-AEAU4CE212 D7-AEAU2CE212 D7-AEAU4CU910 D7-AEAU2CU910	1
07 Replacement Caps, top or bottom, flush	White blank Black blank Green blank Red blank Yellow blank Blue blank	D7-AFU1 D7-AFU2 D7-AFU3 D7-AFU4 D7-AFU5 D7-AFU6	10
08 Replacement Caps, top or bottom, extended	White blank Black blank Green blank Red blank Yellow blank Blue blank	D7-AEU1 D7-AEU2 D7-AEU3 D7-AEU4 D7-AEU5 D7-AEU6	10
09 Tool-less Mounting Latch (for snap-on contact blocks and power module)	Plastic Latch Metal Latch	D7-ALP D7-ALM	10
10 Power Module Integral LED Module	24V AC/DC 120V AC 240V AC	D7-N3W D7-N5W D7-N7W	10
11 Contact blocks ❸	NO NC NO, low voltage NC, low voltage	D7-X10 D7-X01 D7-X10V ❸ D7-X01V ❸	10

❶ Legend plates sold separately. See page H6:11 for information.

❷ See page H6:14 for other custom printed ISO and text options.

❸ Up to 4 contact blocks (in any combination) can be attached to two button operators. Up to 6 contact blocks (3 across / 2 high) can be attached to three button operators.

❹ LED module required for illumination, cannot use incandescent module.

❺ Low voltage contact blocks must be ordered separately.

Multifunction Pushbuttons, Non-Illuminated (Build Your Own) ①

Contact Blocks ②③	Plastic operator with plastic bezel	Metal operator with metal bezel	Contact Blocks ②③	Plastic operator with plastic bezel	Metal operator with metal bezel
	Two Position ④			Three Position ④⑦	
	Catalog Number	Catalog Number		Catalog Number	Catalog Number
Operator Only	D7P-U2♣♣♣♣	D7M-U2♣♣♣♣	Operator Only	D7P-U3♣♣♣♣♥	D7M-U3♣♣♣♣♥
2	D7P-U2♣♣♣♣P▼	D7M-U2♣♣♣♣P▼	3	D7P-U3♣♣♣♣♥P▼	D7M-U3♣♣♣♣♥P▼

Complete Kit Ordering Instructions

D7P –	U2	★	◆	♣	♠	♥	P	▼
Oper. Construction	Oper. Style	Bottom Cap Type	Bottom Color/Text ④	Top Cap Type	Top Color/Text ④	Middle Color/Text	Mounting Latch	Contacts ②③
D7P - Plastic operator with plastic bezel (Type 4/4X, IP66) D7M - Metal operator with metal bezel (Type 4, IP66)	U2 - Two function U3 - Three function	F - Flush E - Extended X - No caps (all positions) ⑦	1 - White blank 2 - Black blank 3 - Green blank 4 - Red blank 5 - Yellow blank 6 - Blue blank Standard Text Options ⑤ A - Green Start B - Red Stop C - White Start D - Black Stop E - Green I F - Red O G - White I H - Black O	F - Flush E - Extended	1 - White blank 2 - Black blank 3 - Green blank 4 - Red blank 5 - Yellow blank 6 - Blue blank Standard Text Options ⑤ A - Green Start B - Red Stop C - White Start D - Black Stop E - Green I F - Red O G - White I H - Black O	4 - Red blank B - Red Stop F - Red O	P - Plastic latch <i>(D7P and D7M offered with plastic latch as standard)</i> M - Metal latch <i>List price changes</i>	X20 - 2NO X02 - 2NC X11 - 1NO/1NC X30 - 3NO X03 - 3NC X21 - 2NO/1NC X12 - 1NO/2NC
<p>Only Standard Inscription caps are available in Kit form. Other custom printed cap options on page H76 must be purchased separately. Order kits above with "No Caps" and order the custom printed cap separately for field installation.</p>								

↻ Positive Opening per EN60947-5-1 (applies to all NC contact block styles)

Standard Inscription Caps ⑤		
Color	Text	
	Flush Caps	Extended Caps
White	START, I	—
Black	—	Stop, O
Green	START, I	—
Red	—	Stop, O

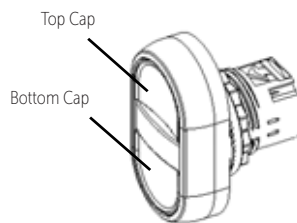

Two Position Multi-Function ⑥

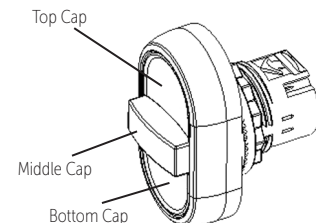



Three Position Multi-Function ⑥

- ① Legend plates sold separately. See page H6:11 for information.
- ② Up to 4 contact blocks (in any combination) can be attached to two button operators. Up to 6 contact blocks (3 across / 2 high) can be attached to three button operators.
- ③ See page H6:12 for complete kit ordering information on other special contact blocks: Early make, late break, low voltage contact blocks.
- ④ Blank color caps included in base number. Choose standard text options or order with "no caps" and order custom text caps from page H6:14.

- ⑤ Valid standard "complete kit" cap type and cap color/text selection. List price changes.
- ⑥ Mounting latch slot 1 (left position when viewed for the back) corresponds to the Top Cap pushbutton of the operator. Slot 2 of the mounting latch (right position when viewed from the back) corresponds to the Bottom Cap pushbutton of the operator.
- ⑦ For "no caps" option, (position B) center cap available as red, no text only.

Multifunction Pushbuttons, Illuminated (Build Your Own) ①⑥

Contact Block(s) ②③	Plastic operator with plastic bezel	Metal operator with metal bezel
		
	Two Position ④	Two Position ④
	Catalog Number	Catalog Number
Oper. Only	D7P-LU2②③♣♣	D7M-LU2②③♣♣
Integral LED Module		
2	D7P-LU2②③♣♣P★▼	D7M-LU2②③♣♣P★▼

Complete Kit Ordering Instructions

D7P	–	LU2	★	◆	♣	♠	P	★	▼
Oper. Construction	Oper. Style	Bottom Cap Type	Bottom Color/Text ④	Top Cap Type	Top Color/Text ④	Mounting Latch	Middle Cap White Lens Power Module ⑥	Contacts ②③	
D7P - Plastic operator with plastic bezel (Type 4/4X, IP66)	LU2 - Two function, illuminated	F - Flush E - Extended	1 - White blank 2 - Black blank 3 - Green blank 4 - Red blank 5 - Yellow blank 6 - Blue blank Standard Text Options ⑤ A - Green Start B - Red Stop C - White Start D - Black Stop E - Green I F - Red O G - White I H - Black O	F - Flush E - Extended	1 - White blank 2 - Black blank 3 - Green blank 4 - Red blank 5 - Yellow blank 6 - Blue blank Standard Text Options ⑤ A - Green Start B - Red Stop C - White Start D - Black Stop E - Green I F - Red O G - White I H - Black O	P - Plastic latch (D7P and D7M offered with plastic latch as standard) M - Metal latch <i>List price changes</i>	Integral LED module N3W, 24V AC/DC N5W, 120V AC N7W, 240V AC	X20 - 2NO X02 - 2NC ↻ X11 - 1NO/1NC	
<p><i>Only Standard Inscription caps are available in Kit form. Other custom printed cap options on page H76 must be purchased separately. Order kits above with "No Caps" and order the custom printed cap separately for field installation.</i></p>									

Standard Inscription Caps ⑤		
Color	Text	
	Flush Caps	Extended Caps
White	START, I	—
Black	—	STOP, O
Green	START, I	—
Red	—	STOP, O

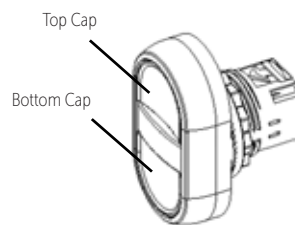

Two Position Illuminated Multi-Function ⑦

↻ Positive Opening per EN60947-5-1 (applies to all NC contact block styles)

- ① Legend plates sold separately. See page H6:11 for information.
- ② Up to 4 contact blocks can be attached.
- ③ See page H6:12 for complete kit ordering information on other special contact blocks.
- ④ Blank color caps included in base number. Choose standard text options or order with "no caps" and order custom text caps from page H6:14.
- ⑤ Valid standard "complete kit" cap type and cap color/text selection. List price changes
- ⑥ LED module required for illumination, cannot use incandescent module. Lens color available in white only.

- ⑦ Mounting latch slot 1 (left position when viewed for the back) corresponds to the Top Cap pushbutton of the operator. Slot 2 of the mounting latch (right position when viewed from the back) corresponds to the Bottom Cap pushbutton of the operator.

Selector/Jog Operators (Complete Kits) ①

Contact Blocks ②③	Two Position Selector/Jog		Three Position Selector/Jog	
	Plastic Jog Operator	Metal Jog Operator	Plastic Jog Operator	Metal Jog Operator
	Catalog Number	Catalog Number	Catalog Number	Catalog Number
Oper. Only	D7P-SJ2 Ⓢ	D7M-SJ2 Ⓢ	D7P-SJ3 Ⓢ	D7M-SJ3 Ⓢ
1NO	D7P-SJ2 ⓈPX10	D7M-SJ2 ⓈPX10	D7P-SJ3 ⓈPX10	D7M-SJ3 ⓈPX10
1NC	D7P-SJ2 ⓈPX01	D7M-SJ2 ⓈPX01	D7P-SJ3 ⓈPX01	D7M-SJ3 ⓈPX01
2NO	D7P-SJ2 ⓈPX20	D7M-SJ2 ⓈPX20	D7P-SJ3 ⓈPX20	D7M-SJ3 ⓈPX20
2NC	D7P-SJ2 ⓈPX02	D7M-SJ2 ⓈPX02	D7P-SJ3 ⓈPX02	D7M-SJ3 ⓈPX02
1NO/1NC	D7P-SJ2 ⓈPX11	D7M-SJ2 ⓈPX11	D7P-SJ3 ⓈPX11	D7M-SJ3 ⓈPX11
3NO	D7P-SJ2 ⓈPX30	D7M-SJ2 ⓈPX30	D7P-SJ3 ⓈPX30	D7M-SJ3 ⓈPX30
3NC	D7P-SJ2 ⓈPX03	D7M-SJ2 ⓈPX03	D7P-SJ3 ⓈPX03	D7M-SJ3 ⓈPX03
2NO/1NC	D7P-SJ2 ⓈPX21	D7M-SJ2 ⓈPX21	D7P-SJ3 ⓈPX21	D7M-SJ3 ⓈPX21
1NO/2NC	D7P-SJ2 ⓈPX12	D7M-SJ2 ⓈPX12	D7P-SJ3 ⓈPX12	D7M-SJ3 ⓈPX12

Complete Kit Ordering Instructions

D7P –	SJ2	★	P	▼
Oper. Construction	Oper. Style	Lens Cap Color	Mounting Latch	Contacts ②③
D7P - Plastic operator with plastic bezel (Type 4/4X, IP66)	SJ2 - 2 Position selector/jog SJ3 - 3 Position selector/jog	2 - Black 3 - Green	P - Plastic latch (D7P and D7M offered with plastic latch as standard) Metal latch M - List price changes	X10 - 1NO X01 - 1NC → X20 - 2NO X02 - 2NC X11 - 1NO/1NC X30 - 3NO X03 - 3NC X21 - 2NO/1NC X12 - 1NO/2NC

→ Positive Opening per EN60947-5-1 (applies to all NC contact block styles)

Contact Type	Position on Mounting Latch	Selector Left Free		Selector Right Free	
		Selector Left Depressed	Selector Right Depressed	Selector Left Depressed	Selector Right Depressed
N.O.	Left	O	X	O	O
N.O.	Right	O	O	O	X
N.O.	Center	O	X	O	X
N.C.	Left	X	O	X	X
N.C.	Right	X	X	X	O
N.C.	Center	X	O	X	O

Note: X = Closed, O = Open

Contact Type	Position on Mounting Latch	Selector Left Free		Selector Center Free		Selector Right Free	
		Selector Left Depressed	Selector Center Depressed	Selector Left Depressed	Selector Center Depressed	Selector Right Depressed	Selector Center Depressed
N.O.	Left	O	X	O	X	O	O
N.O.	Right	O	O	O	X	O	X
N.O.	Center	O	X	O	X	O	X
N.C.	Left	X	O	X	O	X	X
N.C.	Right	X	X	X	O	X	O
N.C.	Center	X	O	X	O	X	O

- ① Legend plates sold separately. See page H6:11 for information.
- ② Up to 6 contact blocks (3 across/ 2 high) can be attached.
- ③ See page H6:12 for complete kit ordering information on other special contact blocks: Early make, late break, low voltage contact blocks.

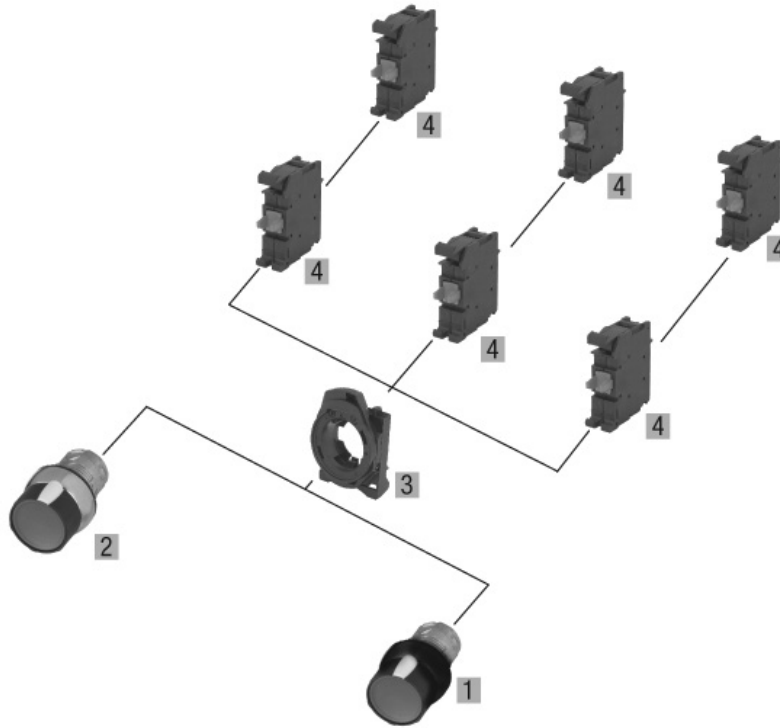

Selector/ Standard Jog Operators (Components)



Component	Catalog Number	Pkg. Qty.
01 Plastic operator, 2-position, with plastic bezel selector/jog ❶ Black Cap Green Cap	D7P-SJ22 D7P-SJ23	1
Plastic operator, 3-position, with plastic selector/jog ❶ Black Cap Green Cap	D7P-SJ32 D7P-SJ33	1
02 Metal operator, 2-position, with shiny metal bezel selector/jog ❶ Black Cap Green Cap	D7M-SJ22 D7M-SJ23	1
Metal operator, 3-position, with shiny metal selector/jog ❶ Black Cap Green Cap	D7M-SJ32 D7M-SJ33	1
03 Tool-less Mounting Latch Plastic Latch Metal Latch	D7-ALP D7-ALM	10
04 Contact Blocks ❷ NO NC NO, low voltage NC, low voltage	D7-X10 D7-X01 D7-X10V ❸ D7-X01V ❸	10

- ❶ Legend plates sold separately. See page H6:11 for information.
- ❷ Up to 6 contact blocks (3 across/ 2 high) can be attached.
- ❸ Low voltage contact blocks must be ordered separately.

Reset Operators Mechanical and/or Electrical Reset ①②⑤

Color Cap	Legend Text	Plastic operator with plastic bezel Type 4/4X/13, IP66	Metal operator with metal bezel Type 4/13, IP66
			
		Catalog Number	Catalog Number
White	<i>no text</i>	D7P-R1	D7M-R1
Black	<i>no text</i>	D7P-R2	D7M-R2
Blue	<i>no text</i>	D7P-R6	D7M-R6
White	R	D7P-R111	D7M-R111
Black	R	D7P-R211	D7M-R211
Blue	R	D7P-R611	D7M-R611

Reset Rods ③

Rod Length	Rod Length Adjustability				
		Threaded with 10mm Push Head		Threaded with 35mm Push Head	
		Catalog Number	Pkg. Qty.	Catalog Number	Pkg. Qty.
1.57" (40 mm)	1.35-2.05" (34-52 mm)	D7-ATR01	1	D7-ATR01L	1
2.17" (55 mm)	1.95-2.65" (50-67 mm)	D7-ATR02		D7-ATR02L	
3.35" (85 mm)	3.15-3.85" (80-98 mm)	D7-ATR04		D7-ATR04L	
4.53" (115 mm)	4.35-5.05" (110-128 mm)	D7-ATR06		D7-ATR06L	
5.70" (145 mm)	5.55-6.25" (141-159 mm)	D7-ATR08		D7-ATR08L	
12.28" (315 mm)	6.18-12.85" (157-326 mm)	D7-ATR19 ④		D7-ATR19L ④	

- ① Legend plates sold separately. See page H6:11 for information.
- ② Will accept latch and up to four single circuit contact blocks; no contacts allowed in center position.
- ③ If contact blocks are used, they must have a minimum rod length of 55mm for one level of contact blocks and 85mm for two levels of contact blocks.
- ④ Rod is threaded along its entire length. Fully threaded rod can be provided after cutting.
- ⑤ 11 mm reset stroke length.

Toggle Switch (Operator Only) ②③④



Metal Operator with metal bezel
 Type 4/13, IP66



2 Position		4 Position	
Momentary	Maintained	Momentary	Maintained
Catalog Number	Catalog Number	Catalog Number	Catalog Number
D7M-JR2	D7M-JM2	D7M-JR4	D7M-JM4





Important Note:
 Cannot use N.C. or N.O.E.M. contact blocks with 4 position toggle switches. Contact blocks and mounting latches sold separately, see pages H6:7 and H6:5.

Target Table and Operator Positions (2 Position)

Contact Type	Position on Mounting Latch			
		Toggle Left	Center	Toggle Right
N.O.	Left	O	O	X
N.O.	Right	X	O	O
N.O.	Center	X	O	X
N.C.	Left	X	X	O
N.C.	Right	O	X	X
N.C.	Center	O	X	O

Note: X = Closed / O = Open

Target Table and Operator Positions (4 Position) ①

Contact Type	Position on Mounting Latch					
		Toggle Up	Toggle Left	Center	Toggle Right	Toggle Down
N.O.	Left	X	O	O	O	O
N.O.	Right	O	X	O	O	O
N.O.	Center	X	X	O	O	O
N.C.L.B.	Left	O	X	X	X	X
N.C.L.B.	Right	X	O	X	X	X
N.C.L.B.	Center	O	O	X	X	X
N.C.E.B.	Left	O	O	O	O	X
N.C.E.B.	Right	O	O	O	X	O

Note: X = Closed / O = Open

- ① Cannot use N.C. or N.O.E.M. contact blocks with 4-position toggle switches. Must use N.O., N.C.E.B. or N.C.L.B. contact bodies.
- ② Contact blocks and mounting latches sold separately, see pages H6:5 and H6:7.
- ③ Silicone boot comes standard with toggle switch, see page H6:10 for replacement boots.
- ④ Use legend plates D7-34... and D7-35... on page H6:11.

Single Turn Potentiometer Assembly¹²



Single Turn Potentiometer	
Resistive Element	Catalog Number
None (Operator Only)	D7P-POTA
150 Ω	D7P-POT1A
500 Ω	D7P-POT2A
1000 Ω	D7P-POT3A
2500 Ω	D7P-POT4A
5000 Ω	D7P-POT5A
10000 Ω	D7P-POT6A

The D7P-POTA is a complete operator assembly supplied without the resistive element, used with potentiometers having a shaft diameter of 6.0 mm (0.23 in.) and a shaft length of 50.0 mm (1.97 in.), or a shaft diameter of 6.4 mm (0.25 in.) and a shaft length of 22.5 mm (0.88 in.) This operator is used with Type "J" potentiometers only.

Accessories

Component	Description	Catalog Number	Pkg Qty.
	Potentiometer Legend Plate scale 0-9 Note: Sold in multiples of 10. Order (quantity of) 10 to receive one package of 10 pieces.	D7-30WN	10
	Potentiometer Legend Plate graphical scale Note: Sold in multiples of 10. Order (quantity of) 10 to receive one package of 10 pieces.	D7-30WG	

Component	Description	Resistance	Catalog Number	Pkg. Qty.
	Replacement Resistive Elements for the D7P Potentiometer operator ¹	150 Ω	D7-AC1	1
		500 Ω	D7-AC2	
		1000 Ω	D7-AC3	
		2500 Ω	D7-AC4	
		5000 Ω	D7-AC5	
		10000 Ω	D7-AC6	

¹ Rated 300VAC/DC, 2W max.

² A mounting latch is not needed.

Combine light and sound with Panel Mount Beacons and Alarms from



Auer Signal

Long life LED lighting for enhanced indication and panel mounted alarms up to 105 dB



When A Pilot Light Is Not Enough...

enhance your signaling needs with light and sound.

Beacons

Auer Signal offers an array of panel mount beacons designed for 22 mm diameter mounting holes. These beacons offer incandescent bulbs or long lasting LED bulb options. Multi-faceted polycarbonate lenses offer an enhanced panel indication available in 12 V to 240 V AC/DC. Selections are available in Steady, Flashing Strobe, Multi-Strobe and Dual colors on the same unit. See the complete selection of Auer panel mount beacons in Section J.

Alarms

When a simple indicator is not enough, add a panel mount alarm. Auer Signal alarms mount into standard 22 mm diameter panel holes, right next to other pilot devices. In three sizes, and up to 105 dB of sound, signaling critical control issues is incorporated right into the panel door. Easily configured with DIP switches, choose from pulsing wobble or continuous tone options. And the 30 mm ESK model is fully enclosed, which is suitable for use in food industry applications.



Beacons I at 65, 45 & 30 mm ø

Combine Light + Sound

The Series I beacons with alarm combine both light control and alarm signaling in one unit. Available in two sizes for mounting into a standard 22mm diameter panel hole. Choose the light and tone synchronized or separately controlled. Tones from 98 to 103 dB are easily selected via terminals.



Panel Mount Beacons with integrated alarms

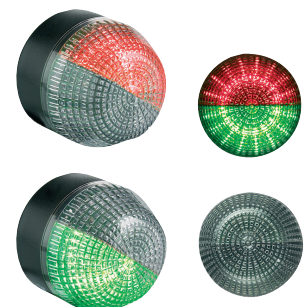

M22 Dual Color beacons



M22 Alarms



Fits seamlessly into control panel along with other control devices.

H4

D7 Pilot Devices

Indicating Lights (Complete Kits) ①②

Lens Color	Plastic operator with plastic bezel	Metal operator with metal bezel
		
	Diffuser Type	Diffuser Type
	Catalog Number	Catalog Number
Oper. Only	D7P-P 	D7M-P 
Incandescent Module (Bulb Included)		
Green	D7P-P3P 	D7M-P3P 
Red	D7P-P4P 	D7M-P4P 
Yellow	D7P-P5P 	D7M-P5P 
Blue	D7P-P6P 	D7M-P6P 
Clear	D7P-P7P 	D7M-P7P 
Integral LED Module		
Green	D7P-P3P 	D7M-P3P 
Red	D7P-P4P 	D7M-P4P 
Yellow	D7P-P5P 	D7M-P5P 
Blue	D7P-P6P 	D7M-P6P 
Clear	D7P-P7P 	D7M-P7P 

H4

D7 Pilot Devices

Complete Kit Ordering Instructions

D7P	–	P	★	P	♣
Oper. Construction	Operator Type ③	Lens Color	Mounting Latch	Power Module	
D7P - Plastic operator with plastic bezel (Type 4/4X/13, IP66)	P - Diffuser style lens	0 - Amber 3 - Green 4 - Red 5 - Yellow 6 - Blue 7 - Clear	P - Plastic latch <i>(D7P and D7M offered with plastic latch as standard)</i> M - Metal latch <i>List price changes</i>	Incandescent module D0 - no bulb D1 - 6V, bulb D2 - 12V, bulb D3 - 24V, bulb D4 - 48V, bulb D5 - 120V, bulb Integral LED module N3x, 24V AC/DC N5x, 120V AC N7x, 240V AC	

Custom printed diffusers sold separately, see page H76. Order kits with applicable lens cap color and order the custom printed diffuser separately for field installation.

LED Module Code Selection	
For lens color...	replace "x" with...
Green	G
Red	R
Amber Yellow Blue Clear	W

- ① Legend plates sold separately. See page H6:11 for information.
- ② Select lens color from "Complete Kit Ordering Instructions" table above.
- ③ One blank inscription diffuser included.

Indicating Lights (Components) ❶

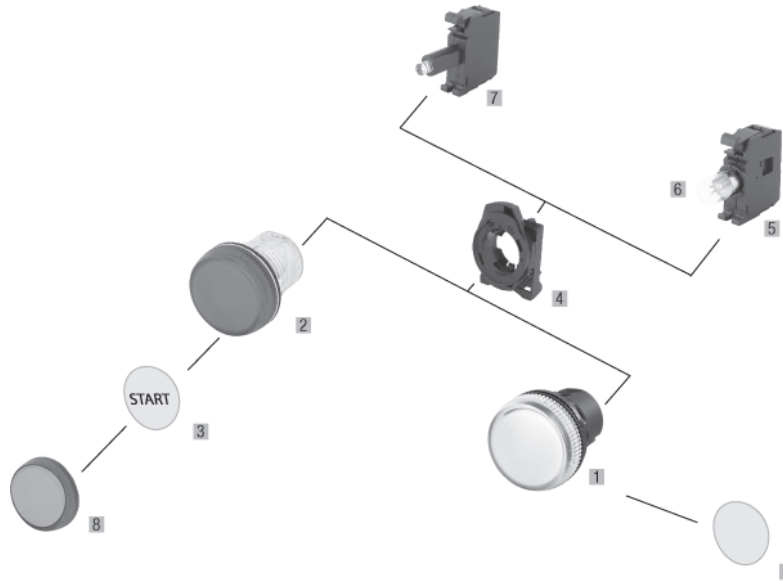



Component	Catalog Number	Pkg. Qty.
01 Plastic operator with blank diffuser Amber Green Red Yellow Blue Clear	D7P-P0 D7P-P3 D7P-P4 D7P-P5 D7P-P6 D7P-P7	1
02 Metal operator with blank diffuser Amber Green Red Yellow Blue Clear	D7M-P0 D7M-P3 D7M-P4 D7M-P5 D7M-P6 D7M-P7	1
03 Custom printed Inscription diffuser caps ❸ AUTO CLOSE DOWN FAULT FAST FORWARD HAND HIGH LOW OFF ON OPEN REVERSE RUN SLOW START STOP UP	D7-AD3CE101 D7-AD3CE107 D7-AD3CE110 D7-AD3CE113 D7-AD3CE114 D7-AD3CE120 D7-AD3CE126 D7-AD3CE129 D7-AD3CE148 D7-AD3CE163 D7-AD3CE166 D7-AD3CE170 D7-AD3CE188 D7-AD3CE193 D7-AD3CE201 D7-AD3CE208 D7-AD3CE212 D7-AD3CE223	1

Component	Catalog Number	Pkg. Qty.
04 Tool-less Mounting Latch (for snap-on contact blocks and lamp elements) Plastic Latch Metal Latch	D7-ALP D7-ALM	10
05 Power Module, Incandescent	D7-D0C	10
06 Lamps, Incandescent 6V AC/DC 12V AC/DC 24V AC/DC 48V AC/DC 130V AC/DC	D7-N65 D7-N141 D7-N157 D7-N48 D7-N130	10
07 Power Module, Integral LED ❷❹ 24V AC/DC 120V AC 240V AC	D7-N3x D7-N5x D7-N7x	10
08 Replacement color lens cap, includes blank diffuser Amber Green Red Yellow Blue Clear	D7-AP0 D7-AP3 D7-AP4 D7-AP5 D7-AP6 D7-AP7	10

- ❶ Legend plates sold separately. See page H6:11 for information.
- ❷ Screwless power modules available. See page H6:7 for ordering information.
- ❸ See page H6:14 for other custom printed ISO and text options.
- ❹ To complete the catalog no., replace the "x" with one of the codes on the previous page.

Momentary Pushbutton Devices, Non-Illuminated (Complete Assembly) ①

Cap Color	Legend Text	Contact Block(s) ②③	Plastic Operator	
				
			Flush Momentary Pushbutton	Extended Momentary Pushbutton
			Catalog Number	Catalog Number
~	~	1NO	D7D-F④▼X10	
		1NC	D7D-F④▼X01	D7D-E④▼X01
		1NO/1NC	D7D-F④▼X11	D7D-E④▼X11
		2NO	D7D-F④▼X20	
		2NC	D7D-F④▼X02	D7D-E④▼X02
Quick Selection Guide				
Green	Blank	1NO	D7D-F3X10	
	START	1NO	D7D-F301X10	
	I	1NO	D7D-F306X10	
Red	Blank	1NC	D7D-F4X01	D7D-E4X01
	STOP	1NC	D7D-F402X01	D7D-E402X01
	0	1NC	D7D-F405X01	D7D-E405X01

PRODUCT FEATURES

- Easy installation
- Available with flush or extended cap
- Two color molding and laser engraved options for cap
- UL type 4/4X/13, IP 66

H5

Complete Kit Ordering Instructions

D7D	–	F	★	▼	X	10
Oper. Construction	Operator Type	Color Cap	Inscription ①②④	Screw Termination	Contacts	
D7D - Plastic operator with plastic bezel (Type 4/4X/13, IP66)	F - Flush, momentary, non-illuminated E - Extended, momentary, non-illuminated	0 - Orange 1 - White 2 - Black 3 - Green 4 - Red ⑤ 5 - Yellow 6 - Blue	<i>Omit this position for a blank color cap</i> Standard Molded Caps 01 - START 02 - STOP ⑤ 05 - O ⑤ 06 - I 08 - → ③ 09 - FORWARD 10 - REVERSE 11 - R	X - Standard R - Ring Lug ⑥ SPECIAL ORDER	10 - 1NO ⑥ 01 - 1NC → 20 - 2NO ⑤ 02 - 2NC → 11 - 1NO/1NC	

→ Positive Opening per EN60947-5-1 (applies to all NC contact block styles)

Standard Molded Inscription Caps ③④

Molded Cap Selection Table		
Color	Text Flush Caps	Text Extended Caps
White	START, I, →, R, FORWARD, REVERSE	→, R
Black	→, R, FORWARD, REVERSE	STOP, O, →, R, ⑤
Green	START, I, →, FORWARD, REVERSE	→
Red	STOP, O, →, FORWARD, REVERSE ⑤	STOP, O, → ⑤
Yellow	→, FORWARD, REVERSE	→
Blue	→, R, FORWARD, REVERSE	→, R

- ① Legend plates sold separately. See page H6:11 for information.
 ② One blank color cap included. For standard molded inscription caps list price changes.
 ③ Rotation every 90° (→, ←, ↓, ↑). All legend caps supplied loose for customer installation.

- ④ Valid color cap/legend text codes. White and yellow caps have black text. All other caps have white text.
 ⑤ "Stop", "0", or Red Blank Color Cap/Legend text button caps are not available for "10" or "20" contact codes.
 ⑥ Available with Ring Lug terminals. Minimum quantities may apply.

Emergency Stop Operators, Push-Pull and Twist-to-Release (Complete Assembly) **1****2****4****5**

Contact Block(s) 1 2	Plastic operator 
	40mm Mushroom 3
	Catalog Number
1NC	D7D-MT44X01
1NO 1NC	D7D-MT44X11
2NC	D7D-MT44X02

PRODUCT FEATURES

- Push-pull and twist-to-release in one device
- Non-removable contacts promote safety in E-stop applications
- Arrows molded on cap indicate direction of release
- Trigger action anti-tease feature
- Externally tamper proof
- 40 mm mushroom cap
- Non-illuminated
- E-Stops meet the EN ISO13850 and EN 60947-5-5 standards
- UL type 4/4X/13, IP 66

Complete Kit Ordering Instructions









D7D	-	MT4	4	X	01
<u>Operator</u>		<u>Operator Type</u>	<u>Cap Color</u>	<u>Screw Termination</u>	<u>Contacts</u> 2
D7D - Plastic Operator (UL Type 4/4X/13, IP66)		MT4 - Push-Pull/ Push-to-release	4 - Red 4E - Red-EMO 3	X - Standard	01 - 1NC  11 - 1NO/1NC 02 - 2NC

Text in Gray is **SPECIAL ORDER**

 Positive Opening per EN60947-5-1 (applies to all NC contact block styles)

1 Legend plates sold separately. See page H6:11 for information.
2 E-Stops must contain at least 1 NC contact.
3 Special Order. Minimum quantities may apply. List price changes.
4 Operators are EN ISO13850 compliant when using at least one N.C. contact block.
5 Operators have been third-party tested for B10d values. B10d values can be found in approval document EL660_01_10 online at www.sprecherschuh.com.

Selector Switch Devices, Non-Illuminated (Complete Assembly) ①

Switching Positions	Contact Block(s)	Plastic operator	
			
		2 Position Selector Switch	3 Position Selector Switch
		Catalog Number	
	1NO	D7D-SM22X10	
	1NC	D7D-SM22X01	
	2NO	D7D-SM22X20	
	2NC	D7D-SM22X02	
	1NO & 1NC	D7D-SM22X11	
	1 Contact	D7D-SL22X▼	
	2 Contacts	D7D-SL22X▼	
	1 Contact	D7D-SR22X▼	
	2 Contacts	D7D-SR22X▼	

PRODUCT FEATURES

- Positive detent decreases the likelihood of hang-up between positions
- Constant energy solution means vibration or a slight bump should not cause a change in state
- UL type 4/4X/13, IP 66

H5

Complete Kit Ordering Instructions

D7D	-	S	M	2	2	X	▼
Oper. Construction	Operator Type	Operator Function	Operator Position	Knob Color	Screw Termination	Contacts	
D7D - Plastic operator with plastic bezel (Type 4/4X/13, IP66)	S - Standard knob	M - Maintained, 60° switching angle L - Spring return from left, 60° R - Spring return from right, 60° B - Spring return from left and right, 60° ②	2 - 2 Position, 60° switching angle 3 - 3 Position, 60° switching angle	2 - Black knob, white insert	X - Standard R - Ring Lug ④ SPECIAL ORDER	10 - 1NO ③ 01 - 1NC ③ 20 - 2NO 02 - 2NC 11 - 1NO/1NC	

D7D Monolithic Devices

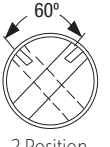
Contact Development Table					
Contacts/ Contact Position (from back)	2 Position Selector Switch				
	L		R		
	L	R	L	R	
01 (1NC)	X	-	O	-	2 Position Switching Angle
10 (1NO)	-	O	-	X	
11 (1NO 1NC)	X	O	O	X	
02 (2NC)	X	X	O	O	
20 (2NO)	O	O	X	X	

Contact Development Table							
Contacts/ Contact Position (from back)	3 Position Selector Switch						
	L		R		L		
	L	R	L	R	L	R	
11 (1NO 1NC)	O	O	X	O	X	X	3 Position Switching Angle
02 (2NC)	O	X	X	X	X	O	
20 (2NO)	X	O	O	O	O	X	

① Legend plates sold separately. See page H6:11 for information.
 ② Only available on 3-position selector switch.
 ③ Only available on 2-position selector switch.
 ④ Available with Ring Lug terminals. Minimum quantities may apply.

Indicating Lights (Complete Assembly) ①③

Lens Color	Plastic Operator	
		
	Optically Enhanced ③	
	Catalog Number	
Oper. Only	D7D-P9D0 ⑥	
	Incandescent Module (Bulb Included)	Integral LED Module ②
Amber	D7D-P0D♣	D7D-P0N♣
Green	D7D-P3D♣	D7D-P3N♣
Red	D7D-P4D♣	D7D-P4N♣
Yellow	D7D-P5D♣	D7D-P5N♣
Blue	D7D-P6D♣	D7D-P6N♣
Clear	D7D-P7D♣	D7D-P7N♣

PRODUCT FEATURES

- Optically enhanced lens style
- Available in six colors: Amber, green, red, yellow, blue and clear
- UL Type 4/4X/13, IP66

INCANDESCENT

- Device comes with bulb installed for quick set-up
- Bulb is front-replaceable

LED

- Superior shock and vibration ratings
- Life rating of 100,000 hours
- Leakage current protection up to 3 mA
- Integrated LED





Complete Kit Ordering Instructions

D7D	-	P	3	D	♣	
Operator	Operator Type	Lens & LED Color	Illumination Type	Power Module	Screw Termination	
D7D - Plastic Operator (UL Type 4/4X/13, IP66)	P - Optically enhanced lens (cannot use inscription options)	0 - Amber 3 - Green 4 - Red 5 - Yellow 6 - Blue 7 - Clear 9 - No Lens ④ (Incandescent only)	D - Incandescent N - LED	Incandescent 0 - no bulb ⑥ 1 - 6V, bulb 2 - 12V, bulb 3 - 24V, bulb 4 - 48V, bulb 5 - 120V, bulb Integral LED 3 - 24V AC/DC 5 - 120V AC 7 - 240V AC	Blank - Standard R - Ring Lug ①	SPECIAL ORDER

Component	Catalog Number	Pkg. Qty.
Replacement Lenses - Optically Enhanced		
Amber	D7D-AP0	10
Green	D7D-AP3	
Red	D7D-AP4	
Yellow	D7D-AP5	
Blue	D7D-AP6	
Clear	D7D-AP7	

- ① Pilot lights available with Ring Lug terminals. Minimum quantities may apply.
- ② LED modules are not replaceable or sold separately.
- ③ Legend plates sold separately. See page H6:11 for information.
- ④ Only valid with "no bulb" option.
- ⑤ Only valid with "no lens" option. See page H6:8 to purchase bulbs separately.
- ⑥ Applies to incandescent pilot lights only (does not include lens or bulb).

Pushbutton Enclosures and Pendant Stations ❶

Pushbutton Station	Description	Catalog Number	Dimensions		
			Length	Width	Depth
Type 1 - General Purpose - Painted Steel ❸					
	One (1) Hole gray	M1-100	4-1/2"	2-5/8"	2-3/4"
	Two (2) Hole - gray	M1-200	4-1/2"	2-5/8"	2-3/4"
	Three (3) Hole - gray	M1-300	6-1/4"	2-5/8"	2-3/4"
Type 4/13 (IP66) Oil & Dust-tight - Aluminium (UL/CSA Approved) ❸❹					
	One (1) Hole - yellow	D7-1MYP	3-9/32"	3-11/32"	3-5/32"
	One (1) Hole - gray	D7-1MP	3-9/32"	3-11/32"	3-5/32"
	Two (2) Hole - gray	D7-2MP	15-13/32"	3-11/32"	3-5/32"
	Three (3) Hole - gray	D7-3MP	6-27/32"	3-11/32"	3-5/32"
	Five (5) Hole - gray	D7-5MP	9-13/16"	3-11/32"	3-5/32"
Type 4/4X/13 (IP66) Dust-tight and Corrosion Proof - Plastic (UL/CSA Approved) ❸❹					
	One (1) Hole - yellow	D7-1YP	3-11/32	3-1/2	2-9/32
	One (1) Hole - gray	D7-1PP	3-11/32	3-1/2	2-9/32
	Two (2) Hole - gray	D7-2PP	4-7/8	3-1/8	2-9/32
	Three (3) Hole - gray	D7-3PP	6-3/32	3-1/8	2-9/32
	Four (4) Hole - gray	D7-4PP	7-5/16	3-1/8	2-9/32
	Six (6) Hole - gray	D7-6PP	9-3/4	3-7/16	2-17/32
Pendant Station Type 4/4X/13 (IP66) Dust-tight and Corrosion Proof - Plastic (UL/CSA Approved) ❸					
	1 hole in face	D7-P15	5.87"	2.36"	3.19"
	2 holes in face	D7-P25			
	1 hole in bottom	D7-P35			
	1 hole in face / 1 hole in bottom	D7-P45			

Complete Assemblies ❷

Pushbutton Enclosures can either be purchased "stand alone," or completely outfitted with the standard pilot device combinations listed on the opposite page. Each enclosure accepts up to three contact blocks on each pilot device (one deep).

The Type 1 enclosure accepts standard latch mount contact blocks and power modules. The Type 4 and 4X enclosures accept base mount or latch mount contact blocks and power modules. Pendant stations are latch mount only.

If purchasing components separately for self-assembly, order enclosure and, if necessary, base mount or latch mount contact blocks and lamp elements from this page, then turn to appropriate page to order pilot devices.

H6

D7 Pilot Devices

Component	Catalog Number	Pkg. Qty.
Tool-less Mounting Latch (for snap-on contact blocks and power module)	D7-ALP D7-ALM	10
Contact blocks		
NO	D7-X10	10
NC	D7-X01 ⇨	
NO, early make	D7-X10E	
NC, late break	D7-X01L ⇨	
NO, low voltage	D7-X10V	10
NC, low voltage	D7-X01V ⇨	
Base Mounted Contact blocks		
NO	D7-BX10	10
NC	D7-BX01 ⇨	

⇨ Positive Opening per EN60947-5-1 (applies to all NC contact block styles)

Component	Catalog Number	Pkg. Qty.
Lamps, Incandescent		
6V AC/DC	D7-N65	10
12V AC/DC	D7-N141	
24V AC/DC	D7-N157	
48V AC/DC	D7-N48	
130V AC/DC	D7-N130	
Incandescent Module		
no bulb	D7-DOC	10
Integrated LED Module ❸		
24V AC/DC	D7-N3x	10
120V AC	D7-N5x	
240V AC	D7-N7x	
Base Mounted Integrated LED Module ❸		
24V AC/DC	D7-BN3x	10
120V AC	D7-BN5x	
240V AC	D7-BN7x	
Ground Screw Kit For plastic enclosures only	D7-AGS2	10

Ordering Instructions

- Specify Catalog Number
- If applicable, add suffix from opposite page for complete Pushbutton Station assembly
- Total the list price of the pushbutton enclosure and the modification selected

- ❶ Accepts 2-piece snap-in legends. See panel hole spacing requirements on page H7:6. Inscription rings possible with 1-hole enclosure only.
- ❷ All "Complete Assembly" orders for two and three pilot devices should be accompanied by a sketch showing position of elements in enclosure.
- ❸ Will accept one stack of latch mount contact blocks (1-3 contact blocks).
- ❹ Will accept base mount and latch mount type contact blocks and power modules (1-3 contact blocks).
- ❺ To complete the catalog no., replace the x with one of the following letters for desired color: Y = Yellow, R = Red, G = Green, B = Blue, W = White.

Pushbutton Enclosure Modifications ❶

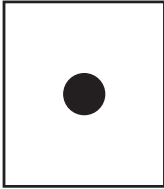
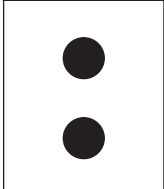
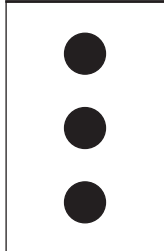
Number of Elements	Description	Standard Contacts	Cat. Number Suffix	
	One Pushbutton ❷			
	START (Green)	1NO	-101 ⚡	
	STOP (Extended Cap - Red)	1NC	-102 ⚡	
	STOP (40mm mushroom - Red)	1NC	-104 ⚡	
	One Selector Switch			
	OFF-ON	1NO	-108 ⚡	
	OPEN-CLOSE	1NO/1NC	-109 ⚡	
	HIGH-LOW	1NO/1NC	-111 ⚡	
	FOR-REV	1NO/1NC	-112 ⚡	
	UP-DOWN	1NO/1NC	-113 ⚡	
	HAND-OFF-AUTO	2NO	-115 ⚡	
	MAN-AUTO	1NO/1NC	-116 ⚡	
	FAST-SLOW	1NO/1NC	-117 ⚡	
One Pilot Light				
Red (Incandescent 120 Volt)		-118 ⚡		
Red (Incandescent 240 Volt)	~	-119 ⚡		
Red (LED Module 120 Volt)		-120 ⚡		
Red (LED Module 240 Volt)		-121 ⚡		
	Two Pushbuttons ❷			
	START (Green) / STOP (Extended Cap - Red)	1NO/1NC	-201 ⚡	
	OFF (Black) / ON (Black)	1NO/1NC	-202 ⚡	
	FOR (Black) / REV (Black)	2NO/2NC	-203 ⚡	
	UP (Black) / DOWN (Black)	2NO/2NC	-204 ⚡	
	OPEN (Black) / CLOSE (Black)	2NO/2NC	-205 ⚡	
	HIGH (Black) / LOW (Black)	2NO/2NC	-206 ⚡	
	One Pilot Light & One Pushbutton ❷			
	Red (120 Volt) / START (Green)	1NO	-210 ⚡	
	Red (240 Volt) / START (Green)	1NO	-211 ⚡	
	Red (120 Volt) / STOP (Extended Cap - Red)	1NC	-215 ⚡	
	Red (240 Volt) / STOP (Extended Cap - Red)	1NC	-216 ⚡	
	Red (LED Module 120 Volt) / START (Green)	1NO	-217 ⚡	
Red (LED Module 240 Volt) / START (Green)	1NO	-218 ⚡		
Red (LED Module 120 Volt) / STOP (Extended Cap - Red)	1NC	-219 ⚡		
Red (LED Module 240 Volt) / STOP (Extended Cap - Red)	1NC	-220 ⚡		
	Three Pushbuttons ❷			
	OPEN (Black) / CLOSE (Black) / STOP (Extended Cap - Red)	2NO/3NC	-302 ⚡	
	UP (Black) / DOWN (Black) / STOP (Extended Cap - Red)	2NO/3NC	-303 ⚡	
	FOR (Black) / REV (Black) / STOP (Extended Cap - Red)	2NO/3NC	-304 ⚡	
	HIGH (Black) / LOW (Black) / STOP (Extended Cap - Red)	2NO/3NC	-305 ⚡	
	One Selector Switch & Two Pushbuttons ❷			
	HIGH-LOW / START (Green) / STOP (Extended Cap - Red)	2NO/2NC	-307 ⚡	
	UP-DOWN / START (Green) / STOP (Extended Cap - Red)	2NO/2NC	-308 ⚡	
	FOR-REV / START (Green) / STOP (Extended Cap - Red)	2NO/2NC	-309 ⚡	
	One Pilot Light & Two Pushbuttons ❷			
	Red (120 Volt) / START (Green) / STOP (Extended Cap - Red)	1NO/1NC	-311 ⚡	
	Red (240 Volt) / START (Green) / STOP (Extended Cap - Red)	1NO/1NC	-312 ⚡	
	Red (LED Module 120V) / START (Green) / STOP (Ext. Cap - Red)	1NO/1NC	-313 ⚡	
Red (LED Module 240V) / START (Green) / STOP (Ext. Cap - Red)	1NO/1NC	-314 ⚡		

Custom Assemblies

Only the most popular combinations are listed in this table. If your application calls for five control units, or you require different pilot device or contact block configurations, consult with your Sprecher + Schuh sales representative for pricing and ordering information.

NOTE: On pushbutton combinations such as UP-DOWN, FOR-REV, HIGH-LOW, etc., we provide two additional contacts for an interlock circuit.

H6
D7 Pilot Devices



⚡ = P - D7P Plastic devices, no price change
M - D7M Metal devices, list price changes

Ordering Instructions

- Add catalog suffix to the end of the enclosure catalog number on previous page
- Total the list price of the pushbutton enclosure and the modification selected

- ❶ All Pushbutton Enclosure modification orders for two and three pilot devices should be accompanied by a sketch showing the position of all elements.
- ❷ All pushbuttons have white lettering on the color indicated.

Emergency Stop Pushbutton Stations ①②

Pushbutton Station	Description	Catalog Number	Dimensions		
			Length	Width	Depth
	Type 4/13 (IP66) - Oil & Dust Tight – Yellow aluminium 30mm twist-to-release E-stop 40mm twist-to-release E-stop 60mm twist-to-release E-stop Gray aluminium 30mm twist-to-release E-stop 40mm twist-to-release E-stop 60mm twist-to-release E-stop	D7-1MYPB13-⊕▼-◆ D7-1MYPB14-⊕▼-◆ D7-1MYPB16-⊕▼-◆ D7-1MPB13-⊕▼-◆ D7-1MPB14-⊕▼-◆ D7-1MPB16-⊕▼-◆	3.28"	3.34"	4.93"
	Type 4/13 (IP66) - Oil & Dust Tight – Yellow aluminium 40mm twist-to-release keyed E-stop Gray aluminium 40mm twist-to-release keyed E-stop	D7-1MYPBK14-⊕▼-◆ D7-1MPBK14-⊕▼-◆	3.28"	3.34"	4.93"
	Type 4/4X/13 (IP66) - Dust Tight and Corrosion Proof – Yellow plastic 30mm twist-to-release E-stop 40mm twist-to-release E-stop 60mm twist-to-release E-stop Gray plastic 30mm twist-to-release E-stop 40mm twist-to-release E-stop 60mm twist-to-release E-stop	D7-1YPB13-⊕▼-◆ D7-1YPB14-⊕▼-◆ D7-1YPB16-⊕▼-◆ D7-1PB13-⊕▼-◆ D7-1PB14-⊕▼-◆ D7-1PB16-⊕▼-◆	3.34"	3.50"	4.05"
	Type 4/4X/13 (IP66) - Dust Tight and Corrosion Proof – Yellow plastic 40mm twist-to-release keyed E-stop Gray plastic 40mm twist-to-release keyed E-stop	D7-1YPBK14-⊕▼-◆ D7-1PBK14-⊕▼-◆	3.34"	3.50"	4.05"

Base Mount Contact Block Codes ②

Code	Contacts
X10	1NO
X01	1NC
X20	2NO
X02	2NC
X11	1NO/1NC
X30	3NO
X03	3NC
X21	2NO/1NC
X12	1NO/2NC

List price changes over 2 blocks

H6
D7 Pilot Devices

Enclosure Accessories

Component	Catalog Number	Pkg. Qty.
Ground Screw Kit This accessory is used for grounding on D7 plastic enclosures only.	D7-AGS2	10

- ⊕ = P - D7P Plastic devices, no price change
- M - D7M Metal devices, list price changes
- ▼ = See Base Mount Contact Block table
- ◆ = ER - Emergency Stop Ring (D7-15YE112), list price change applies.



Ordering Example

• Specify Catalog Number	
• Replace (▼) with Contact Block Code and Operator Type	See Contact Block Code table on this page
• Include price adder when applicable	

- ① Will accept one stack of base mount contact blocks (1-3 contact blocks).
- ② Accepts two piece snap-in legends and 60 mm emergency stop legends.

Accessories

Component	Description	Catalog Number	Pkg. Qty
	<p>Plastic Mounting Latch - Attaches to plastic or metal operators. Note: Sold only in multiples of 10. Order (quantity of) 10 to receive one package of 10 pieces.</p>	D7-ALP	10
	<p>Metal Mounting Latch - Attaches to plastic or metal operators. These are zinc-plated, metal die cast mounting latches. Note: Sold only in multiples of 10. Order (quantity of) 10 to receive one package of 10 pieces.</p>	D7-ALM	10
	<p>Ground Screws These are self-tapping #6-32 (M3.5) ground screws for metal latches. Note: Sold only in multiples of 10. Order (quantity of) 10 to receive one package of 10 pieces.</p>	D7-AGS1	10
	<p>Stab Terminals Can be used with all single circuit contact blocks. Minimum spacing requirements apply. See instruction sheet for details. Note: Sold only in multiples of 100. Order (quantity of) 100 to receive one package of 100 pieces.</p>	D7-ATK2	100
	<p>Selector Switch Tabs Changes functionality of selector switch from normal to CenterLeft or CenterRight. For customers that want to use the center position of a mounting latch to add an additional circuit to the left or right actuator without stacking contacts.</p>	D7-ACP	10
	<p>30mm to 22mm Hole Size Adapter This adapter allows a 22mm push button operator to be installed in a panel with existing 30mm mounting holes. Cast Stainless Steel Note: Comes with anti-rotation washer (D7-ALC1)</p>	D7-AHA1	1
	<p>Replacement Mounting Rings Plastic Metal</p>	D7-ARP D7-ARM	10
	<p>Mounting Ring Wrench This mounting ring wrench is used to tighten plastic or metal mounting rings quickly and securely.</p>	D7-AW2	1
	<p>Lens/Bulb Removal Tool The small end of this tool provides quick and easy removal of an incandescent lamp.</p>	D7-ALR1	1

Accessories (Cont.)

Component	Description	Catalog Number	Pkg. Qty
	Locking Washer (Anti-Rotation Washer) This item provides an extra anti-rotation feature for rotary operators such as selector switches.	D7-ALC1	10
	Square Bezel Gives round operator a square appearance. This item is made of plastic. Not for use with toggle switch operators.	D7-ABZ1	10
	Snap-In Marker This item can be used for circuit identification on all back-of-panel components. (contact blocks and power modules)	V7-SM5X9	~

Inscription Rings

Component	Description	Catalog Number	Pkg. Qty		
	Standard Inscription Self-Adhesive Rings ①		10		
	Outside Diameter	Mounting Hole		Color	Inscription
	60mm Round	22.5 mm		Yellow	"EMERGENCY STOP" ②
	60mm Round	30 mm		Yellow	"EMERGENCY STOP"
	90mm Round	22.5 mm		Yellow	"EMERGENCY STOP"
	Special Order Inscription Self-Adhesive Rings ①				
	60mm Round	22.5 mm		Yellow	See table ②
60mm Round	30 mm	Yellow	See table		
90mm Round	22.5 mm	Yellow	See table		
Note: Sold only in multiples of 10. Order (quantity of) 10 to receive one package of 10 pieces.					

Ordering Instructions

CAT. NO.	Inscription
D7- 15YS E112	EMERGENCY STOP
M112	EMERGENCY STOP, ARRÊT D'URGENCE, NOT AUS
15Y E112	EMERGENCY STOP
F112	ARRÊT D'URGENCE
M112	NOT AUS, ARRESTO EMERGENZA, ARRÊT D'URGENCE
B112	EMERGENCY STOP, ARRÊT D'URGENCE, PARADA DE EMERGENCIA
16Y E112	EMERGENCY STOP
F112	ARRÊT D'URGENCE
M112	NOT AUS, ARRESTO EMERGENZA, ARRÊT D'URGENCE
B112	EMERGENCY STOP, ARRÊT D'URGENCE, PARADA DE EMERGENCIA

Other languages available. Contact your S+S representative.

① Sold only in multiples of 10. Order (quantity of) 10 to receive one package of 10 pieces.

② Not for use with base mounted contact blocks.



Accessories

Component	Description	Contact Type	Catalog Number	Pkg. Qty.
	Contact Blocks ❶ Latch mounted contact blocks	NO NC NOEM, early make NCLB, late break NCEB, early break ❷ NO, low voltage NC, low voltage	D7-X10 D7-X01 D7-X10E D7-X01L D7-X01B D7-X10V D7-X01V	10
	Guardian Contact Block ❸ Latch mounted contact block	Guardian Block ❸	D7-X01S	10
	Base Mounted Contact Block ❶ Base mounted contact blocks can be used in plastic or metal enclosures. (D7x-MP/D7-1YP/D7x-PP)	NO NC	D7-BX10 D7-BX01	10
	Incandescent Power Module (bulb not included) ❺ Latch mounted power module for use with illuminated pilot lights, push buttons, and momentary mushroom operators.	No bulb	D7-D0C	10
	Integrated Power LED Module ❺ Latch mounted power module for use with all illuminated devices.	24V AC/DC 120V AC 240V AC	D7-N3x D7-N5x D7-N7x	10
		24...120V AC/DC ❹	D7-NUx	10
		24V AC/DC, screwless 120V AC, screwless 240V AC, screwless	D7-Q3x D7-Q5x D7-Q7x	10
	Base Mounted Integrated Power LED Module Base mounted modules can be used in plastic or metal enclosures.	24V AC/DC 120V AC 240V AC	D7-BN3x D7-BN5x D7-BN7x	10



LED Module Code Selection	
For lens color...	replace "x" with...
Green	G
Red	R
Amber, Yellow, Blue, Clear	W



- ❶ Sold in multiples of 10. Order (quantity of) 10 to receive one package of 10 pieces.
- ❷ Only for use with 4 Position selector switch, 4 position toggle switch, or 3 position push-pull operator.
- ❸ Guardian Contact blocks cannot stack.
- ❹ D7-NUx available as a component only. Not available in assembled pilot device kits.
- ❺ A maximum of four circuits allowable when a power module is used. Contact blocks cannot be stacked on power modules.

Replacement Lamps ③

Lamp	Type	Bulb Wattage	Typical Current	Volts	ANSI No.	Catalog Number	Pkg. Qty.
	Full voltage incandescent	0.95 W	150mA	6V AC/DC	755	D7-N65	10
		1.12 W	80mA	12V AC/DC	756	D7-N141	
		2.24 W	70mA	24V AC/DC	757	D7-N157	
		2.40 W	50mA	48V AC/DC	1835	D7-N48	
		2.86 W	22mA	130V AC/DC	949	D7-N130	
	Neon	0.95 W	22mA	240V AC	-----	D7-N240	10

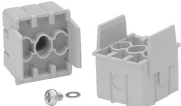
Accessories

Component	Description	Catalog Number	Pkg. Qty.
	Ground Screws This accessory is used for grounding on D7 plastic enclosures only. (D7-1xP/D7-xPP)	D7-AGS2	10
	Replacement Trim Washer This accessory comes standard with all enclosures. It must be utilized if using base-mounted contact blocks/power modules without legend plates.	D7-ATW1	10
	Replacement Base Mount Adapter This accessory comes standard with all metal enclosures. It is required when using metal enclosures with base-mounted contact blocks or base-mounted power modules. (D7-xMP)	D7-A3BA	10







Component	Description	"Ronis" Key No.	Catalog Number	Pkg. Qty.	
	Replacement Ronis Key Standard replacement key is Cat. No. D7-AKR3825 <i>Note: Minimum order quantity is one package of 2 pieces.</i>		3825	D7-AKR3825	1 set ②
			455	D7-AKR455	
3801	D7-AKR3801				
3802	D7-AKR3802				
3803	D7-AKR3803				
3804	D7-AKR3804				
3805	D7-AKR3805				
3806	D7-AKR3806				
4001	D7-AKR4001				
4002	D7-AKR4002				
4003	D7-AKR4003				
4004	D7-AKR4004				
4005	D7-AKR4005				
4006	D7-AKR4006				
4007	D7-AKR4007				
3901 ①	D7-AKR3901				
3910 ①	D7-AKR3910				
3920 ①	D7-AKR3920				

① Master key. See diagram for master key system details.

② Minimum order quantity is one package of 2 keys.

③ Sold in multiples of 10. Order (quantity of) 10 to receive one package of 10 pieces.

Locking Attachments



Component	Description	Type	Catalog Number	Pkg. Qty
	<p>Locking Attachments are used to lock Push Button in the depressed position.</p> <ul style="list-style-type: none"> - N.C. contacts are open - N.O. contacts may or may not be open - N.C.L.B contacts may or may not be closed - N.O.E.M contacts are closed 	Flush, Momentary, Non-illuminated	D7-AFL1	1
		Extended, Momentary, Non-illuminated	D7-AEL1	1
		Momentary Mushroom	D7-AML1	1
		Maintained Mushroom	D7-AML2	1
	<p>Locking Cover</p> <p>Used on Flush, Extended and Guarded Momentary and Maintained Operators, and Standard Knob Selector Switch Operators.</p>	~	D7-AL01	1
	<p>Selector Switch Locking Attachment</p> <p>Locks selector switch in specified position</p>	2-Position Selector Switches, Left Lock	D7-ASL2L	1
		3-Position Selector Switches, Center Lock	D7-ASL3C	1
	<p>Selector Switch Locking Attachment</p> <p>Ability to put two locks on standard knob selector switch.</p>	2- or 3-Position Selector Switches, All Positions	D7-ASL23A	1

Protective Guards





Component	Description	Type	Catalog Number	Pkg. Qty
	40 mm Protective Guard used with illuminated and non-illuminated momentary mushroom operators (40 mm) only.	Shiny Metal	D7-AMMG	1
	Protective Ring for use with <ul style="list-style-type: none"> • Illuminated/Non-Illuminated 2-Position Maintained • Illuminated/Non-illuminated 3-Position Mushroom (30mm and 40mm only) 	Shiny Metal	D7-AMRG	1
		Black Metal Yellow Metal	D7-AMRGB D7-AMRGY	
	Plastic Guard for use with the following operators: <ul style="list-style-type: none"> • 40mm E-Stop (SEMI Standards Compliant) • 40mm Illuminated/Non-Illuminated Maintained and Momentary operators • 60mm Illuminated/Non-Illuminated Momentary operators • Selector Switches (standard knob and key operated) • Potentiometer 	Yellow, Round	D7-A6PR5	1
	Narrow Plastic Guard for use with the following operators: <ul style="list-style-type: none"> • D7D Monolithic E-Stops • Flush/Extended/Guarded Push Buttons • Maintained Operators (SEMI standards compliant) • Selector Switches (standard knob and key operated) • Potentiometers 	Yellow, Plastic	D7-AMEGY	1
	Clear Silicone Protective Boot used on illuminated and Non-illuminated, flush and extended operators. Note: Sold in multiples of 10. Order (quantity of) 10 to receive one package of 10 pieces.	Flush Push Button	D7-AB7	10
		Extended Push Button	D7-ABE7	
		3-Position Multi-Function	D7-AUB1	
		2-Position Multi-Function	D7-AUB2	





H6
D7 Pilot Devices

Accessories

Component	Description	Material	Catalog Number	Pkg. Qty
	Replacement Boot for Toggle Switch (D7M-JMR)	Silicone Nitrile	D7-ABJS D7-ABJN	1
	Hole Plug used to plug 22.5mm holes. - UL Type 4, 4X, 13, IP66	Black Plastic Gray Plastic	D7-N2 D7-N8	1

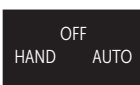
Legend Plates

Component	Description	Catalog Number	Pkg. Qty
	Legend Plate Frame 30 x 40 mm	D7-110	10
	Legend Plate Frame 30 x 50 mm	D7-120	10
	Legend Plate Frame (for use with multi-function operator) 30 x 60 mm	D7-200	10
	Legend Plate Frame (for use with multi-function operator) 50 x 50 mm	D7-400	10

Component	Description	Blank Legend Plate		With Text or Symbols	
		Catalog Number	Pkg. Qty	Catalog Number	Pkg. Qty
	Legend Plate - for D7-110 Legend Plate Frame White with black text Black with white text Aluminum with black text	D7-17WE100 D7-17BE100 D7-17AE100	10	D7-17W***** D7-17B***** D7-17A*****	1
	Legend Plate - for D7-120 & D7-200 Legend Plate Frame White with black text Black with white text Aluminum with black text	D7-18WE100 D7-18BE100 D7-18AE100	10	D7-18W***** D7-18B***** D7-18A*****	1
	Legend Plate - for D7-400 Legend Plate Frame ① White with black text Black with white text Aluminum with black text	D7-42WE100 D7-42BE100 D7-42AE100	10	D7-42W***** D7-42B***** D7-42A*****	1
	Legend Plate 30 x 40 mm White plastic Black plastic Aluminum	D7-34WE100 D7-34BE100 D7-34AE100	10	D7-34W***** D7-34B***** D7-34A*****	1
	Legend Plate 30 x 50 mm White plastic Black plastic Aluminum	D7-35WE100 D7-35BE100 D7-35AE100	10	D7-35W***** D7-35B***** D7-35A*****	1

Example: Cat. No. **D7-17WE101** identifies a white legend plate with blank text, 30 x 40 mm snap-in legend plate with AUTO engraved in it.

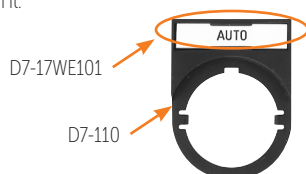

- Select the catalog number for the appropriate legend size and color from the Selection Tables on this page.
- Complete the catalog number by adding the appropriate suffix number starting on page H6:17.

① Three snap-in legend plates are required for each D7-400 legend plate frame.

Complete Kits with Special Contact Blocks ①③

P		X		0		1		L	
Mounting Latch		Contact Block Style ①		NO Circuits ③		NC Circuits ③		Specialty Blocks ①②	
Code	Description	Code	Description	Code	Description	Code	Description	Code	Description
P	Plastic Latch	X	Screw Termination	0	No Contact	0	No Contact	blank	Standard blocks
M	Metal Latch			1	1 NO	1	1 NC	V	Low voltage
				2	2NO	2	2 NC	E	NO, early make
				3	3 NO	3	3 NC	L	NC, late break
				4	4 NO	4	4 NC	S	Guardian block
				5	5 NO	5	5 NC		

Ordering Example:

Select Operator Only: D7M-E4④ (from page H1:8) List Price: _____ (Navigate to the Price look up tool on the E-Catalog)
(Momentary pushbutton metal operator, extended, red blank cap)

Back of panel requirements: Plastic latch, screw type termination, 1 NC late break contact block

P - Plastic Latch	D7-ALP	\$_____
X - Screw terminals	~	no adder
0 - No Contact required	~	no adder
1L - 1 NC, late break contact blocks	D7-X01L	\$_____
Total List Price adder for "PX01L" =		\$_____

Complete Kit Catalog Number: D7M-E4PX01L List Price = _____ (Operator + Latch+ Contact Block)

- ① Configuration must be the same contact block style. Example: X11E acceptable sequence (X2Q1 Not Possible)
- ② Specialty blocks can not be combined. Example: X01L acceptable sequence (X11EV not possible).
- ③ Up to 6 contact blocks (in any combination) can be attached. Up to 4 additional contacts when using the Guardian contact block.

Complete Illuminated Kits with Special Power Modules ①③

P		N		3		R	
Mounting Latch		Power Module Type ①		Voltage		LED Color ②	
Code	Description	Code	Description	Code	Description	For lens color...	use code...
P	Plastic Latch	D	Incandescent module, screw type	0	No bulb	Green	G
M	Metal Latch	N	Integral LED module, screw type	1	6V AC/DC	Red	R
				2	12V AC/DC	Amber	W
				3	24V AC/DC ②	Yellow	
				4	48V AC/DC	Blue	
				5	120V AC/DC ②	Clear	
				7	240V AC ②		

Ordering Example:

Select Operator Only: D7P-P4▼ (page H4:12) List Price: _____ (Navigate to the Price look up tool on the E-Catalog)

(Plastic pilot light, red blank lens color)

Back of panel requirements: Plastic latch, Integral LED, 24VDC, Red Light

P - Plastic Latch	D7-ALP	\$_____
N - Integral LED Module	D7-N3R	\$_____
3 - Voltage 24VDC	~	no adder
R - Red LED Color	~	no adder
Total List Price adder for "PN3R" =		\$_____

Complete Kit Catalog Number: D7P-P4PN3R List Price = _____ (Operator + Latch + Module)

- ① LED modules for use with all illuminated operators. Incandescent module for use with pilot lights, push buttons, and momentary mushroom operators only.
- ② Integral LED module available in 24V AC/DC, 120V AC or 240V AC only.
- ③ A maximum of four circuits allowable when a power module is used. Contact blocks cannot be stacked on power modules.

Complete Kits with Power Modules and Special Contact Blocks ①②④

M		N		5		G		Continued
Mounting Latch		Power Module Type ②		Voltage		LED Color ③		
Code	Description	Code	Description	Code	Description	For lens color...	use code...	
P	Plastic Latch	D	Incandescent module, screw type	0	No bulb	Green	G	
M	Metal Latch	N	Integral LED module, screw type	1	6V AC/DC	Red	R	
				2	12V AC/DC	Amber	W	
				3	24V AC/DC ③	Yellow		
				4	48V AC/DC	Blue		
				5	120V AC/DC ③	Clear		
				7	240V AC ③			

Q		1		1		Specialty Blocks	
Contact Block Style		NO Circuits ①		NC Circuits ①			
Code	Description	Code	Description	Code	Description	Code	Description
X	Screw Termination	0	No Contact	0	No Contact	blank	Standard blocks
		1	1 NO	1	1 NC	V	Low voltage
		2	2NO	2	2 NC	E	NO, early make
		3	3 NO	3	3 NC	L	NC, late break
		4	4 NO	4	4 NC	S	Guardian block
		5	5 NO	5	5 NC		

Ordering Example:

Select Operator Only: **D7M-LF3**▼ (page H1:12) List Price: _____ (Navigate to the Price look up tool on the E-Catalog)
 (Illuminated momentary pushbutton, green blank lens cap color)

Back of panel requirement: Metal latch, screwless LED power module termination, 120VAC, Green Light, 1 NO and 1 NC standard contact blocks

M - Metal latch	D7-ALM	\$_____
N - Integral LED Module	D7-N5G	\$_____
5 - Voltage 120V AC/DC	<i>no adder</i>	~
G - Green LED Color	<i>no adder</i>	~
X - Screw terminations	<i>no adder</i>	~
1 - 1 NO contact block	D7-X10	\$_____
1 - 1 NC contact block	D7-X01	\$_____
Total Adder List price for "MN5GX11" =		\$_____

Complete Kit Catalog Number: **D7M-LF3MN5GX11** List Price \$_____ (Operator + Latch + LED Module + two Contact Blocks)

- ① Four circuits maximum allowable when power module is used. Do not stack contact block on power module.
- ② LED modules for use with all illuminated operators. Incandescent module for use with pilot lights, push buttons, and momentary mushroom operators only.
- ③ Integral LED module available in 24V AC/DC, 120V AC or 240V AC only.
- ④ A maximum of four circuits allowable when a power module is used. Contact blocks cannot be stacked on power modules.

Custom Printed Cap Configurator Table ①②③

D7-A		F	3	C	E 166
Code		Type	Color		Suffix No.
E		Push button extended cap	0	Amber	See pages H78-80 for custom printed text/symbol options. Insert suffix code Exxx/Uxxx as shown.
F		Push button flush cap, momentary	1	White	
FA		Pushbutton flush cap, maintained	2	Black	
FAU		Multi-function flush cap (for bottom cap)	3	Green	
EAU		Multi-function extended cap (for bottom cap)	4	Red	
FCU		Multi-function flush cap (for top cap)	5	Yellow	
ECU		Multi-function extended cap (for top cap)	6	Blue	
D		Pilot light diffuser	3	Default code for pilot light diffusers	
D		Illuminated push button diffuser, flush, momentary and maintained	2	Default code for flush diffusers	
D		Illuminated push button diffuser, extended and guarded	4	Default code for extended diffusers	

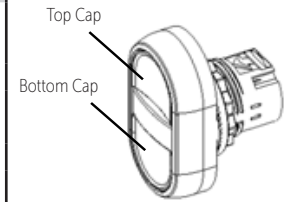

Multi-Function Cap Positions

Standard Text/Symbols (found on pages H6:16...H6:18) ④	Pkg. Qty.
<ol style="list-style-type: none"> Select the cat. no. for the appropriate product and color from the Configurator Table above. Complete the cat. no. by adding the appropriate suffix no. for Standard Text or Symbol Example: Cat. No. D7-AF3CE166 identifies a flush, green cap with custom printed Standard text "ON". Font size is automatically determined by the number of characters. <i>Do not add a font code to the cat. no.</i> 	1

Font Size	No. of Characters Allowed
G (small) (12 pt.)	7
H (standard) (16 pt.)	5..6
J (large) (20 pt.)	1..4

Custom Text (NOT found on pages H6:17...H6:18)	Pkg. Qty.
<ol style="list-style-type: none"> Select the cat. no. for the appropriate product and color from the Configurator Table above. Add E100 followed by the font code (G, H, J), based on the maximum number of custom characters. Complete the cat. no. by adding custom text to the order item's memo text or notes field. Example: Cat. No. D7-AF3CE100J FILL identifies a flush, green push button cap with custom printed text "FILL" in large font. 	1

Font Size	Max. No. of Characters	Max. No. of Lines
G (small) (12 pt.)	7	1
H (standard) (16 pt.)	5..6	1
J (large) (20 pt.)	1..4	1

Custom Symbols/Graphics (Not found on pages H6:16...H6:18)	Pkg. Qty.
<ol style="list-style-type: none"> Select the cat. no. or the appropriate product and color from the Configurator Tables on this page. Add U100 to identify the custom symbol or graphic. Please contact your local Sprecher + Schuh sales office to submit the graphic (in TIF/TIFF format). Example: Cat. No. D7-AD3CU100 	1

- ① Package quantity of one for all standard custom printed caps and diffusers.
- ② Standard font is Arial Narrow
- ③ Font size is automatically determined by the number of characters. Seven characters maximum allowable.
- ④ Seven characters maximum allowable.

Standard Text/Symbols Ordering Information ③

1. Select the catalog number for the appropriate legend size and color from the Selection Tables on page H6:11.
2. Complete the catalog number by adding the appropriate suffix number starting on page H6:17. Font size is automatically determined by the number of characters, as shown in the following table. *Do not add the font code to the catalog number.*

Font Size (automatically selected)	No. of Characters Allowed		
	One-Piece Legend Plate	Two-Piece Legend Plate	Special Multi-Function Legend Plate
K (small)	>14	>13	>6
S (standard)	≤14	≤13	≤6

Example: Cat. No. D7-17WE101 identifies a white, 30 x 40 mm snap-in legend plate with AUTO engraved on it. Font size: S = 0.10 in., order D7-110 legend plate separately.

- ❶ Three snap-in legend plates are required for each D7-400 legend plate frame.
- ❷ Blank legend frames sold only in multiples of 10. Order (quantity of) 10 to receive one package of 10 pieces. Legends with standard text/symbols or custom text are packaged in quantities of 1.
- ❸ Font size K = 0.08 in; font code S = 0.10 in.; font code L = 0.14 in.

Example of Standard Text/Symbol Legend Plate

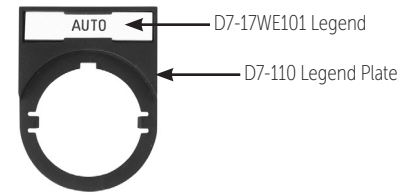

Custom Text Legend Plate Order Form

(Text not found on pages H6:17...H6:18) ②③

Send completed form to:

customerservice@sprecherschuh.com

Customer Information:

Company: _____

Address: _____

City: _____ State: _____ Zip: _____

Today's Date: _____ Order Form _____ of _____

Contact Name: _____

Telephone: _____

Job Reference/PO #: _____

Ordering Instructions:

1. Select the cat. no. for the appropriate legend size and color from the Selection Tables on page H6:11.
2. Add **E100** followed by the font code (K, S, L) from the following table.

Font Size	Type of Legend Plate							Pkg. Qty.	
	One-Piece		Two-Piece		Special Multi-Function				
	Max. Char. per Line	Max. No. of Lines	Max. Char. per Line	Max. No. of Lines	Max. Char. per Line	Max. Lines			
K (small)	16	2	5	15	2	5	7	3	1
S (standard)	14	2	3	13	1	3	6	3	
L (large)	10	1	3	9	1	3	4	2	

Example of Custom Text Legend Plate

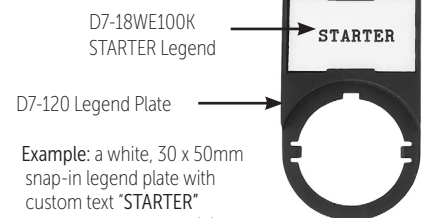

Example: a white, 30 x 50mm snap-in legend plate with custom text "STARTER" engraved in small font (K). Legend plate D7-120 ordered separately.

Completed number = **D7-18WE100K STARTER**

3. Complete the catalog number by adding custom text in the Legend Text Line columns below.

Legend Plate Size/Color				Font
D7-			E100	
Qty:			Of this exact plate	
Price:				
Legend Text				

Legend Plate Size/Color				Font
D7-			E100	
Qty:			Of this exact plate	
Price:				
Legend Text	Line 1			
	Line 2			
	Line 3			
	Line 4			
	Line 5			

Legend Plate Size/Color				Font
D7-			E100	
Qty:			Of this exact plate	
Price:				
Legend Text	Line 1			
	Line 2			
	Line 3			
	Line 4			
	Line 5			

Line 4 and 5 only available in Small Font (K)

Use this form for ordering Custom Legend Plates only.

Standard Symbols *

Marking	Description	Std.	Suffix No.	Marking	Description	Std.	Suffix No.†‡	Marking	Description	Std.	Suffix No.†‡
(Blank)	Blank	–	U100		CONTINUOUS ROTATION TO LEFT	ISO 7B	U708		SETUP	DIN 986	U855
	START †‡♣	ISO 71	U219		INTERRUPTED ROTATION TO LEFT	–	U710		COOLANT FLUID	ISO 101	U875
	– †‡♣	ISO 72	U220		INTERRUPTED ROTATION TO RIGHT	–	U711		LIGHT	ISO 139, 102	U876
	START †‡♣	ISO 5232	U221		DIRECTION OF SPINDLE SPEED	–	U717		WEIGHT	–	U877
	CONTINUOUS MOTION LEFT, RIGHT ▶	–	U226		FEED	ISO 16	U720		REFILLING	DIN 256, ISO 104	U878
	CONTINUOUS MOTION UP, DOWN ▶	–	U227		REDUCED SPEED	–	U723		FULL LEVEL	–	U879
	STOP	–	U228		RAPID FEED	–	U724		DRAIN	DIN 257, ISO 106	U880
I	STEP 1	–	U229		NORMAL FEED	–	U725		OVERFLOW	DIN 258, ISO 105	U881
II	STEP 2	–	U230		LONGITUDINAL FEED	–	U726		OIL LUBRICATION	DIN 175, ISO 107	U882
O-I	STOP-START ▶	–	U231		TRANSVERSE FEED	–	U727		BLOWING UNIT	DIN 263, ISO 108	U883
I-O	START-STOP ▶	–	U232		RAPID TRANSVERSE	ISO 26	U728		SUCTION UNIT	DIN 264, ISO 109	U884
I-II	–▶	–	U233		THREADING	–	U729		STEPLESS OPERATION	ISO 61	U900
I-O-II	–▶	–	U234		INCREASE	ISO 28	U730		CLAMP OR TIGHTEN	ISO 63A	U901
←-O-I	–▶	–	U236		DECREASE	ISO 29	U731		CLAMP OR TIGHTEN	–	U902
	–▶	–	U237		CONVENTIONAL MILLING	–	U736		LOOSEN	ISO 64A	U903
I-II-III	–▶	–	U240		CLIMB MILLING	–	U737		LOOSEN	–	U904
	CONTINUOUS MOTION	–	U241		ELECTRIC MOTOR	ISO 41	U800		BRAKE ON	ISO 65	U905
	CONTINUOUS MOTION	–	U242		TURNING SPINDLE	–	U803		BRAKE RELEASE	ISO 66	U906
	CONTINUOUS MOTION	–	U243		DRILLING SPINDLE	–	U804		AUTO CYCLE	–	U907
III	STEP 3	–	U249		MILLING SPINDLE	–	U805		MANUAL	DIN 35	U908
	–▶	–	U256		GRINDING SPINDLE	–	U806		START	ISO 69	U909
I-O-I	START-STOP-START	–	U282		PUMP	ISO 48	U807		STOP	ISO 70	U910
O-I-2	–▶	–	U285		COOLANT PUMP	–	U808		TAKE ACTION WHEN CONTROL IS OPERATING	–	U912
IV	STEP 4	–	U604		LUBRICATION PUMP	–	U809		ENGAGE	DIN 46, ISO 74	U913
V	STEP 5	–	U605		HYDRAULIC SYSTEMS PUMP	–	U810		DISENGAGE	DIN 45, ISO 74	U914
→	CONTINUOUS MOTION	ISO 1	U700		HYDRAULIC MOTOR	–	U811		ENGAGE TRACE	–	U917
	LINEAR MOTION TWO DIRECTIONS	ISO 2	U701		TRACER	–	U812		DISENGAGE TRACE	–	U918
	VERTICAL MOTION	–	U702		SHEAR PIN CONSTRUCTION	ISO 91	U850		CHANGE SPEED ONLY IN STOPPED POSITION	–	U919
	INTERRUPTED MOTION †‡	–	U703		ATTENTION/DANGER	DIN 131, ISO 92	U851		CHANGE SPEED ONLY WHEN IN MOTION	–	U920
	LIMITED MOTION †‡	ISO 4	U704		CAUTION	ISO 93	U852		CONTINUOUS ADJUSTMENT	ISO 62	U921
	LIMITED MOTION AND RETURN †‡	ISO 5	U705		MAIN SWITCH	ISO 94	U853		AUTOMATIC OR SEMI-AUTOMATIC CYCLE	DIN 267	U922
	OSCILLATING MOTION, CONTINUOUS CYCLE †‡	–	U706		ACOUSTIC WARNING EQUIPMENT	DIN 155	U854		RESET	–	U924
	CONTINUOUS ROTATION TO RIGHT †‡	DIN 100, ISO 7A	U707								

* Items in gray shaded table cells only available on legend plates. Not available as custom printed text on button caps, illuminated push button diffusers, or pilot light diffusers.
 † Not available on -17 legend plates.

‡ Not available on -18 legend plates.
 †† Not available on -34 legend plates.
 ††† Not available on -35 legend plates.
 ▶ Not available on -42 legend plates.

Standard Text *

Marking	Suffix No.	Marking	Suffix No.	Marking	Suffix No.	Marking	Suffix No.	Marking	Suffix No.
(Blank)	E100	FOR-OFF-REV ▶	E261	LAST STOP	E278	PULL TO RESET	E176	START	E208
I-O-AUTO †▶	E235	FOR-REV ▶	E253	LEFT	E145	PUMP STOP	E290	START CYCLE	E209
ACCU-STOP ▶	E284	FOR-STOP-REV ▶	E254	LEFT-RIGHT ▶	E146	PURGE	E271	START-JOG ▶	E210
AT SPEED ▶	E285	FORWARD	E120	LOCAL-REMOTE ▶	E147	PUSH TO STOP	E179	START STOP ▶	E211
AUTO	E101	FORWARD-AUTO-REVERSE ▶	E121	LOW	E148	PUSH TO STOP-TWIST OR PULL RELEASE ‡▶	E262	STOP	E212
AUTO-O-HAND †▶	E250			LOW-HIGH ▶	E149			STOP-CYCLE ▶	E213
AUTO-HAND ▶	E102	FORWARD-OFF-REVERSE ▶	E122	LOW-OFF-HIGH ▶	E150	PUSH-TO-TEST	E181	STOP-RESET ▶	E214
AUTO-MAN-OFF ▶	E103			LOW SPEED	E151	RAISE	E182	STOP-START ▶	E215
AUTO-MANUAL	E286	FORWARD-STOP-REVERSE ▶	E123	LOWER	E152	RAISE-LOWER ▶	E183	SUMMER-OFF-WINTER ▶	E216
AUTO-OFF-HAND ▶	E104			LOW-OFF-RAISE ▶	E153	RAISE-OFF-LOWER ▶	E184		
BLOWER	E268	FORWARD-REVERSE ▶	E124	LOWER-RAISE ▶	E154	READY	E185	SUMMER-WINTER ▶	E217
BRAKE	E105			MANUAL	E155	RESET	E186	SUPPLY ON	E218
BYPASS-OFF-DRIVE †▶	E297	FULL SPEED	E125	MAN-O-AUTO †▶	E238	RETURN	E187	TEST	E219
BYPASS ON †▶	E295	HAND	E126	MAN-AUTO ▶	E258	REV-FOR ▶	E260	TRANSFER ▶	E220
BYPASS START †▶	E299	HAND-I-AUTO †▶	E239	MANUAL-AUTO ▶	E156	REVERSE	E188	TRIP	E221
BYPASS STOP †▶	E298	HAND-O-AUTO ▶	E283	MAN-OFF-AUTO ▶	E259	REVERSE-FORWARD ▶	E189	UNCLAMP	E222
CLAMP	E106	HAND-AUTO ▶	E127	MANUAL-OFF-AUTO ▶	E157		E189	UP	E223
CLOSE	E107	HAND-OFF-AUTO ▶	E128	MOTOR RUN	E158	REVERSE-OFF-FORWARD ▶	E190	UP-DOWN ▶	E224
CYCLE START	E108	HAND OFF	E264	MOTOR RUNNING	E159			E225	
DECREASE ▶	E109	HAND ON	E263	MOTOR START	E160	RIGHT	E191		
DRIVE-START ▶	E287	HAND START	E265	MOTOR STOP	E161	RIGHT-LEFT ▶	E192		
DRIVE-STOP ▶	E288	HAND STOP	E266	MOTOR STOPPED	E162	ROTATE CW	E246		
DOWN	E110	HEAT	E270	NO FLIP	E275	ROTATE CCW	E247		
DOWN-OFF-UP ▶	E111	HIGH	E129	OFF	E163	RUN	E193		
DRIVE ON †▶	E296	HIGH-LOW ▶	E130	OFF CIRCUIT	E244	RUN-JOG ▶	E194		
EMERG STOP ▶	E251	HIGH-OFF-LOW ▶	E131	OFF-COOLANT-ON ▶	E164	RUN-SAFE-JOG ▶	E195		
EMERGENCY	E248	IN	E132	OFF-LIGHT-ON ▶	E272	RUNNING	E243		
EMERGENCY OFF ▶	E294	IN-OUT ▶	E133	OFF-ON ▶	E165	SAFE	E196		
EMERGENCY STOP ▶	E112	INCH	E134	ON	E166	SAFE-RUN ▶	E197		
ENABLE	E279	INCH-REV ▶	E257	ON CIRCUIT	E245	SETUP	E198		
ENTER	E277	INCH-REVERSE ▶	E135	ON-OFF ▶	E167	SETUP-RUN ▶	E302		
ERROR	E273	INCH-RUN ▶	E136	ON-OFF-AUTO ▶	E168	SETUP-SERVICE ▶	E199		
EXHAUSTER ▶	E269	INCREASE ▶	E137	ON-STOP-SAFE ▶	E169	SEQUENCE-TEST ▶	E200		
FAULT	E113	INSPECT	E274	OPEN	E170	SLOW	E201		
FAST	E114	JOG	E138	OPEN-CLOSE	E171	SLOWER	E202		
FAST-OFF-SLOW ▶	E289	JOG-FOR ▶	E255	OPEN-OFF-CLOSE ▶	E172	SLOWEST	E203		
FASTER	E115	JOG-FORWARD ▶	E139	OUT	E173	SLOW-FAST ▶	E204		
FEED START	E116	JOG-OFF-RUN ▶	E140	OVERLOAD ▶	E267	SLOW-OFF-FAST ▶	E205		
FEED STOP	E117	JOG-REV ▶	E256	OVERLOAD TRIP ▶	E174	SLOW-STOP-FAST	E206		
FEEDER OFF	E118	JOG-REVERSE ▶	E141	OVERLOAD RESET ▶	E175	SLOW-OFF-START ▶	E207		
FEEDER ON	E119	JOG-RUN ▶	E142	POWER-OFF	E177	SLOW SPEED	E291		
FIFO	E276	JOG-SAFE-RUN ▶	E143	POWER ON	E178	SOFT STOP	E292		
FOR-AUTO-REV ▶	E252	JOG-STOP-RUN ▶	E144	PULL TO START	E180	SPEED	E293		

* Items in gray shaded table cells only available on legend plates. Not available as custom printed text on button caps, illuminated push button diffusers, or pilot light diffusers.
 ‡ Not available on -17 legend plates.

‡ Not available on -18 legend plates.
 † Not available on -34 legend plates.
 ‡ Not available on -35 legend plates.
 ▶ Not available on -42 legend plates.

Standard Text

French (Special Order) *

Marking	Suffix No.	Marking	Suffix No.	Marking	Suffix No.	Marking	Suffix No.	Marking	Suffix No.
A-COUPS	F138	AVANT-ARRÊT-ARRIÈRE ▶	F122	DESCENDRE ▶	F110	HORS MANUEL	F249	MANUEL-ARRÊT ▶	F211
ACCU-STOP ▶	F280			DROIT	F191	LENT	F201	MONTER	F182
ARRIÈRE	F188	AVANT-ARRIÈRE ▶	F124	EN	F247	LENT-ARRÊT-VITE ▶	F205	OUVRIR	F170
ARRÊT	F163	AV-ARR ▶	F290	EN CIRCUIT	F245	M FORCEE	F284	PANNE	F113
ARRÊT D'ENTR	F289	AV-HORS-ARR ▶	F253	EN MANUEL	F250	MANUEL	F126	RAP-HORS-LENT ▶	F285
ARRÊT DOUX	F288	BAS	F148	FERMER	F107	MANUEL-ARRÊT-AUTO ▶	F128	RAPIDE	F114
ARRÊT D'URGENCE ▶	F112	BAS-ARRÊT-HAUT ▶	F150	FREINAGE ▶	F105			RÉGLER	F198
ARRÊT-MANUEL	F251	DEMAR. D-ENTR	F283	GAUCHE	F145	MANUEL-AUTO ▶	F127	SURCHARGE ▶	F254
ARRÊT-MARCHE ▶	F165	DEMAR. -MAN	F252	HAUT	F129			VARIATEUR ALIMENTE	F293
ARRÊT-POMPE	F286	DERIV-ARRET-EFN †	F294	HAUT-HORS-BAS ▶	F131	MANUEL-HORS-AUTO	F157	VIT. ATTEINT	F281
AUTO	F101	DERIV ARRET ‡	F295	HORS	F246	MARCHE	F166	VIT. LENTE	F287
AUTO-MANUEL ▶	F282	DERIV MARCHE ‡	F296	HOR CIRCUIT	F244	-	-	VITESSE	F291
AVANT	F120	DERIVATION ALIMENTE †	F292	HORS-EN ▶	F248	-	-	-	-

Spanish (Special Order) *

Marking	Suffix No.	Marking	Suffix No.	Marking	Suffix No.	Marking	Suffix No.	Marking	Suffix No.
ABRIR	S170	ARRANQUE	S166	DERECHA	S191	MARCHA	S208	PARADA-MARCHA ▶	S165
ADELANTE ▶	S120	ATRAS	S188	EN SERVICIO ▶	S243	MARCHA-PARADA ▶	S211	PARO	S163
ADELANTE-ATRAS ▶	S124	BAJADA	S152	IZQUIERDA ▶	S145	PARAD	S212	SUBIDA	S182
ADELANTE-PARADA-ATRAS ▶	S123	BAJAR	S110	MANUAL	S126	PARADA DE EMERGENCIA ▶	S112	SUBRIR	S223
		CERRAR		MANUAL-AUTO ▶	S127			-	-

German (Special Order) *

Marking	Suffix No.	Marking	Suffix No.	Marking	Suffix No.	Marking	Suffix No.	Marking	Suffix No.
AB	G110	EINRICHTEN ▶	G198	LANGSAM	G201	ÖFFNEN	G170	VOR	G120
AUF	G223	HAND	G128	LINKS	G145	RECHTS	G191	VOR-AUS-ZURÜCK ▶	G122
AUS	G163	HAND-AUS-AUTO ▶	G128	LINKS-RECHTS ▶	G146	SCHNELL	G114	VOR-ZURÜCK ▶	G124
AUS-EIN ▶	G165	HAND-AUTO ▶	G127	NIEDRIG	G148	SENKEN	G152	ZU	G107
BETRIEB	G243	HEBEN	G182	NIEDRIG-AUS-HOCH ▶	G150	STÖRUNG	G113	ZURÜCK	G188
EIN	G166	HOCH	G129	NOT AUS	G112	-	-	-	-

Italian (Special Order) *

Marking	Suffix No.	Marking	Suffix No.	Marking	Suffix No.	Marking	Suffix No.	Marking	Suffix No.
ABBASSARE ▶	T152	AVANTI-DSINS-INDIETRO ▶	T122	DISCESA	T110	IN SERVIZIO ▶	T243	MARCIA-ARRESTO ▶	T211
ALTO	T129			DISINS-INS ▶	T165	LENTO	T201	PREPARARE ▶	T198
APRIRE	T223	AVANTI-INDIETRO ▶	T124	DISINSERITO ▶	T163	MANUALE	T126	RAPIDO	T114
ARRESTO	T212	BASSO	T148	DISTUBO ▶	T113	MANUALE-AUTO ▶	T127	ROTAZIONE CW ▶	T246
ARRESTO EMERGENZA ▶	T112	BASSO-DISINS-ALTO ▶	T150	EMERGENZA ▶	T248	MANUAL-DISINS-AUTO ▶	T128	ROTAZIONE CCW ▶	T247
AUTOMATICO ▶	T101	DESTRA	T191	INDIETRO ▶	T188			SALITA	T182
AVANIT	T120	CHIUDERE ▶	T107	INSERITO ▶	T166	MARCIA	T208	SINISTRA ▶	T145
		-	-	-	-	-	-	-	-

Swedish (Special Order) *

Marking	Suffix No.	Marking	Suffix No.	Marking	Suffix No.	Marking	Suffix No.	Marking	Suffix No.
BACK	N188	HÖGER	N191	NER	N110	UPP	N223	VÄNSTER	N145
FRAM	N120	-	-	-	-	-	-	-	-

* Items in gray shaded table cells only available on legend plates. Not available as custom printed text on button caps, illuminated push button diffusers, or pilot light diffusers.

* Not available on -17 legend plates.

‡ Not available on -18 legend plates.

‡ Not available on -34 legend plates.

‡ Not available on -35 legend plates.

▶ Not available on -42 legend plates.

Front-of-Panel (Operators) ①

Mechanical Ratings

Description		Plastic (D7P)	Metal (D7M)
Vibration (assembled to panel)	[G]	Tested at 10...2000Hz, 1.52mm displacement (peak-to-peak) max./10G max. for 3hr duration, no damage	
Shock	[G]	Tested at 1/2 cycle sine wave for 11ms; no damage at 100G	
Degree of protection ②		UL Type 3/3R/4/4X/12/13 (IP65/66)	UL Type 3/3R/4/12/13 (IP65/66)
Mechanical durability per EN 60947-5-1 (Annex C)		10,000,000 Cycles 1,000,000 Cycles 500,000 Cycles 300,000 Cycles 100,000 Cycles	Momentary push buttons, momentary mushroom Multi-function, Selector Switch, Key Selector Switch, Selector Jog Non-illuminated Push-Pull E-Stop Twist-to-Release E-Stop, Illuminated Push-Pull E-Stop, Maintained Push Buttons, selector switches Potentiometer, Toggle Switch
Operating forces (typical with one contact block)	[N]		Flush/extended = 5N E-stop = 36N Mushroom = 9N
Operating torque (typical application with one contact block)	[N•m]		Selector switch = 0.25 N•m (2.2 lb-in.)
Mounting torque	[N•m]	1.7 N•m (15 lb-in.)	4.4 N•m (40 lb-in.)
Environmental			
Temperature range (operating) ③	[°C]		-25...+70°C (-13...+158°F)
Temperature range (short-term storage)	[°C]		-40...+85°C (-40...+185°F)
Humidity	[%]	50...95% RH from 25...60°C (77...140°F) per: Procedure IV of MIL-STD-810C, Method 507.1 cycling test	
UV Ratings			
All plastic non-illuminated pushbutton caps & e-stops		UV grade polyester and polycarbonate blend, UL UV Category (f2)	
All plastic enclosures		UV grade polyester and polycarbonate blend, UL UV Category (f1)	

Back-of-Panel Components ①

Electrical Ratings

Standard Contact Block Ratings (See page H7:5)			A600, Q600 600V AC AC15, DC 13 to EN 60947-5-1 and UL 508, 17V, 5mA min.	
Low Voltage Contact Block Ratings (See page H7:5)			5V, 1mA DC min. C300, R150, AC 15, DC 13 to EN 60947-5-1 and UL 508	
LED Module Ratings	Nominal Voltage	Range	Current Draw	Frequency
	24...120V AC/DC	20...132V AC/DC	15 mA (AC), 12mA (DC)	50/60 Hz, DC
	24V AC	10...29V AC	31 mA	50/60 Hz
	24V DC	10...30V DC	24 mA	DC
	120V AC	102...132V AC	6 mA	50/60 Hz
	240V AC	204...264V AC	6 mA	50/60 Hz
Thermal current	[A]	10 A max. enclosed (40°C ambient) to UL 508, EN 60947-5-1		
Wire capacity	Screw terminal ⑤	[AWG]	#18...12 AWG (0.75...2.5mm ²) - Max. (2) #14 AWG or (1) #12 AWG	
	Spring-clamp terminal	[AWG]	#18...14 AWG (0.75...1.5mm ²) One per spring clamp, two spring clamps per terminal	
Recommended tightening torque on screw terminals	[N]	0.7...0.9 N•m (6...8 lb-in.)		
Insulation voltage	[V]	$U_i = 690$ V (screw terminal), $U_i = 300$ V (screwless terminal)		
Dielectric strength (minimum)	[V]	2500V for one minute		
External short circuit protection	Standard blocks	10 A type gL/gG cartridge fuse to EN 60269-2-1 or gN (Class J to UL 248-8 or Class C to UL 248-4)		
	Low voltage contact blocks	6 A type gL/gG cartridge fuse to EN 60269-2-1 or gN (Class J to UL 248-8 or Class C to UL 248-4)		
Electrical shock protection		Finger-safe conforming to IP2X		
Mechanical Ratings				
Vibration (assembled to panel)	[G]	10...2000 Hz, 1.52mm displacement (peak-to-peak) max./10G max. 6hr		
Shock	[G]	Tested at 1/2 cycle sine wave for 11ms and no damage at 100G max.		
Contact durability per EN 60947-5-1 (Annex C)		10,000,000 cycles		
Contact operation	NO	Slow double make and break		
	NC, Guardian Block, GCB	Slow double make and break - positive opening ⊖		
	NOEM	Double break / double make / early make		
	NCLB	Double break / double make, late break - positive opening ⊖		
	NCEB	Double break / double make, early break - positive opening ⊖		

① Performance data given in this publication is provided only as a guide for the user in determining suitability and do not constitute a performance warranty of any kind. Such data may represent the results of accelerated testing at elevated stress levels, and the user is responsible for correlating the data to actual application requirements. ALL WARRANTIES AS TO ACTUAL PERFORMANCE, WHETHER EXPRESS OR IMPLIED, ARE EXPRESSLY DISCLAIMED.

② Momentary mushroom operators are IP65, multi-function operators have no Type 13 rating. Plastic operators with keys have no Type 4X rating.

③ Operating temperatures below 0°C (32°F) are based on the absence of freezing moisture and liquids, UL recognized to 55°C (131°F) - incandescent module, max 40°C (104°F).

④ Low voltage contacts are recommended for applications below 17V, 5 mA.

⑤ Wires less than #18 (0.75mm²) may not hold in terminal securely.

Back-of-Panel Components ①, continued

Push button travel to change electrical state		N.C. and N.O.E. M. 1.5 mm (0.060 in.) N.O. and N.C.L.B. 2.5 mm (0.1 in.)
Operating forces (typical)	[N]	3.4 N: each single circuit contact block

Illumination

LED dominant wavelength	Green	[nm]	525 nm
	Red		629 nm
	White		—
LED luminous intensity	Green	[mcd]	780 mcd
	Red		780 mcd
	White		360 mcd
Incandescent maximum wattage	[W]		2.6W

Materials

Springs		Stainless steel and zinc coated music wire
Electrical contacts	Standard	Silver-nickel
	Low voltage	Gold-plated over silver
Terminals	Screw	Brass
	Screwless	Silver-plated brass

H7

Environmental Approval Note: Front elements UL Recognized; Complete assemblies UL Approved. See Table A2 for your application.

This table is extracted from Sprecher + Schuh's UL 508A file and can be used to determine which D7 Pilot Device is approved for a particular enclosure type.

TABLE A2 - Openings in Enclosure

Enclosure Type	Openings May Be Closed By Equipment Marked...
2	2, 3, 3R, 3S, 4, 4X, 6, 6P, 11, 12, 12K, 13
3	3, 3R, 3S, 4, 4X, 6, 6P
3R	3, 3R, 3S, 4, 4X, 6, 6P
3S	3, 3R, 3S, 4, 4X, 6, 6P
4	4, 4X, 6, 6P
4X	4X
6	6, 6P
6P	6P
11	11
12, 12K	12, 12K, 13
13	13

Product Certifications

Certifications	UL, UR (E193035), CSA (206918), CCC, CE
Conformity of Standards - CE marked	NEMA ICS-5; UL 508, EN ISO13850, EN 60947-1, EN 60947-5-1, EN 60947-5-5
Terminal identification	IEC 60947-1
Shipping approvals	ABS
RoHS	✓

① Performance data given in this publication is provided only as a guide for the user in determining suitability and do not constitute a performance warranty of any kind. Such data may represent the results of accelerated testing at elevated stress levels, and the user is responsible for correlating the data to actual application requirements. ALL WARRANTIES AS TO ACTUAL PERFORMANCE, WHETHER EXPRESS OR IMPLIED, ARE EXPRESSLY DISCLAIMED.

Material Listing

Component	For Use with	Material Used
Panel gasket	All operators	Nitrile, TPE
Diaphragm seal	Illuminated push button, non-illuminated push button	Automotive industry acceptable silicone
K-seal	Selector switch, key selector switch, push/twist-to-release E-stop, key E-stop, push/pull mushroom	Nitrile
Diaphragm retainer, return spring I	Illuminated push button, non-illuminated push button, momentary mushroom	Stainless steel
Return spring II	Reset, selector switch, key selector switch, maintained action, push/twist-to-release E-stop, key E-stop, push/pull mushroom	Zinc coated music wire
Button cap/mushroom head	Non-illuminated push button, momentary mushroom, reset, push/twist-to-release E-stop, key E-stop, push/pull mushroom, multi-function	PBT/polycarbonate blend
2-color molded button cap	Non-illuminated push button	PBT/polycarbonate blend
Lens	Multi-function	Acetal
Lens, knob	Illuminated push button, illuminated momentary mushroom, illuminated selector switch	Polyamide
Knob	Non-illuminated selector switch	Glass-filled polyamide
Plastic bezel/bushing I	Non-illuminated push button, illuminated push button, momentary mushroom, selector switch, key selector switch, push/twist-to-release E-stop, key E-stop, push/pull mushroom, multi-function, reset	Glass-filled polyamide
Plastic bezel/bushing II, jam nut	Pilot light, reset jam nut, reset pusher	Glass-filled PBT
Metal bezel/bushing	All metal operators	Zinc
Diffuser	Illuminated push button, pilot light	Polycarbonate
Legend frames	–	Glass-filled polyamide
Plastic mounting ring	All plastic operators	Glass-filled polyamide
Metal mounting ring	All metal operators	Chromated zinc
Plastic latch	–	Glass-filled polyamide
Metal latch	–	Chromated zinc + stainless steel
Plastic enclosure	–	PBT/polycarbonate blend
Metal enclosure	–	Aluminum
Terminal screws	LED module, incandescent module, contact blocks	Zinc-plated steel with chromate
Terminals	LED module, incandescent module, contact blocks	Brass with silver-nickel contacts
Screwless	LED module, incandescent module	Stainless steel
Lamp socket	Incandescent module	Brass
Housing	Incandescent module, LED module	Glass-filled polyamide
Low voltage terminals	Contact blocks	Gold plated silver-nickel contacts
Low voltage spanner	Contact blocks	Gold-plated silver-nickel contacts
Spanner	Contact blocks	Brass with silver-nickel contacts
Boot	Toggle Switch, illuminated push button, non-illuminated push button, multi-function illuminated an non-illuminated	Automotive industry acceptable silicone

Specifications

Mechanical Ratings

Vibration (assembled to panel)	Tested at 10...2000 Hz, 1.52 mm displacement (peak-to-peak) max./10 G max. for 3 hr duration, no damage	
Shock	Tested at 1/2 cycle sine wave for 11 ms; no damage at 100 G	
Degree of protection	IP 66 (Type 3/3R/4/4X/12/13)	
mechanical durability per EN 60947-5-1 (Annex C)	2,000,000 Cycles	Momentary Push Button
	300,000 Cycles	Selector Switch and E-Stop/Push-Pull
Operating forces	Flush/Extended = 9 N, E-stop = 36 N	
Operating torque (typical application with one contact block)	Selector Switch = 0.25 N•m	
Contact operation	N.O.	Slow double make and break
	N.C.	Slow double make and break - positive opening \ominus
Push button travel to change electrical state	N.O.	2.5 mm (0.1 in.)
	N.C.	1.5 mm (0.060 in.)

\ominus Positive Opening per EN60947-5-1 (applies to all NC contact block styles)

Environmental

Temperature range (operating) $\text{\textcircled{1}}$	-25...+60 °C (-13...140 °F)
Temperature range (short term storage)	-40...+85 °C (-40...185 °F)
Humidity	50...95% RH from 25...60 °C (77...140 °F)

UV Ratings

All plastic non-illuminated pushbutton caps & e-stops	UV grade polyester and polycarbonate blend, UL UV Category (f2)
All plastic enclosures	UV grade polyester and polycarbonate blend, UL UV Category (f1)

Electrical Ratings

Standard contact block ratings	B300, R300; AC 15, DC 13; 300 VAC; EN/IEC 60947-5-1 and UL 508, 17V, 5 mA min. (See page H7:5)			
LED Module Ratings	Nominal Voltage	Range	Nominal Current Draw	Frequency
	24V AC	20...26V AC	32 mA	50/60 Hz
	24V DC	18...30V DC	24 mA	DC
	120V AC	102...132V AC	22 mA	50/60 Hz
	240V AC	204...264V AC	22 mA	50/60 Hz
Thermal current	5 A max. enclosed (40 °C ambient) to UL508, EN/IEC 60947-5-1			
Insulation voltage (Ui)	300V			
Wire capacity (screw terminal)	#18...14 AWG (0.75...2.5 mm ²), Max. (2) #14 AWG, uses same size wire only			
Recommendations for Ring Lug termination option $\text{\textcircled{2}}$	6.35 mm (0.250 in.) Max. outer diameter with 3.8 mm (0.148 in.) hole diameter			
Recommended tightening torque on screw terminals	0.7...0.9 N•m (6...8 lb-in.)			
Dielectric strength (minimum)	2500V for one minute			
External short circuit protection	5 A type gL/gG cartridge fuse to EN 60269-2-1 or gN (Class J to UL 248-8 or Class CC to UL 248-4)			
Electrical shock protection	Finger-safe conforming to IP2X			

Illumination

LED Dominant Wavelength	Green	Red	Yellow	Blue	White
	525 nm	629 nm	590 nm	470 nm	
LED Luminous Intensity	Green	Red	Yellow	Blue	White
	780 mcd	780 mcd	600 mcd	168 mcd	360 mcd
Incandescent maximum wattage	2.6 W				

Materials

Springs	Stainless steel and zinc coated music wire
Electrical contacts	Brass with silver-nickel contacts
Terminals	Brass and phosphor bronze
Panel gasket	nitrile and polyester-based TPE
Seal	Nitrile
Button cap/mushroom head	Polyester/polycarbonate blend
Lens (pilot light)	Acrylic
Knob (selector switch)	Glass-filled polyamide
Bezel/bushing, housing	Glass filled polyester
Legend frames	Glass filled polyamide
Mounting ring	Glass filled polyamide
Terminal screws	Zinc-plated steel with chromate
Lamp Socket	Brass and Phosphor bronze

Product Certifications

Certifications	UL, CSA, CCC, CE
Conformity to standards - CE marked	UL 508, EN ISO13850, EN 60947-1, EN 60947-5-1, EN 60947-5-5
Terminal Identification	EN/IEC 60947-1

$\text{\textcircled{1}}$ Operating temperatures below 0°C (32°F) are based on the absence of freezing moisture and liquids.

$\text{\textcircled{2}}$ 3M MV018-R/S # (22...18 AWG) or 3M MVU14-6R/S (#16...14 AWG)

IEC Ratings and Test Values for AC (50 and 60Hz) Control Circuit Contacts ②

Designation ① AC	Utilization Category	Conventional Thermal Current I_{the} (A)	Rated Operation Current I_e (A) at Rated Operational Voltage U_e						VA Rating	
			120V	240V	380V	480V	500V	600V	Make	Break
A600	AC-15	10.0	6.0	3.0	1.9	1.5	1.4	1.2	7200	720
B300	AC-15	5.0	3.0	1.5	~	~	~	~	3600	360
C300	AC-15	2.5	1.5	0.75	~	~	~	~	1800	180

IEC Ratings and Test Values for DC Control Circuit Contacts ②

Designation ① DC	Utilization Category	Conventional Thermal Current I_{the} (A)	Rated Operation Current I_e (A) at Rated Operational Voltage U_e					VA Rating	
			125V	250V	440V	500V	600V	Make	Break
Q600	DC-13	2.5	0.55	0.27	0.15	0.13	0.1	69	69
R150	DC-13	1.0	0.22	~	~	~	~	28	28
R300	DC-13	1.0	0.22	0.1	~	~	~	28	28

NEMA Ratings and Test Values for AC (50 and 60Hz) Control Circuit Contacts ③

Designation ① AC	Therm. Continuous Test Current (A)	Maximum Current (Amps)								VA Rating	
		120V		240V		480V		600V			
		Make	Break	Make	Break	Make	Break	Make	Break	Make	Break
A600	10	60	6.0	30	3.00	15	1.50	12	1.20	7200	720
B300	5	30	3.0	15	1.50	~	~	~	~	3600	360
C300	2.5	15	1.5	7.5	0.75	~	~	~	~	1800	180

NEMA Ratings and Test Values for DC Control Circuit Contacts ③

Designation ① DC	Therm. Continuous Test Current (A)	Maximum Make or Break Current (Amps)			Make or Break at 300V or less (VA)
		125V	250V	301...600V	
Q600	2.5	0.55	0.27	0.10	69
R150	1	0.22	~	~	28
R300	1	0.22	0.11	~	28

① The letter stands for the conventional thermal current, and identifies AC or DC. For example, B is 5A AC. The numbers following the letter are the rated insulated voltage.

② From IEC 60947-5-1.

③ From NEMA Standard ICS 5-2000, Part 1.

Approximate Dimensions – millimeters ①

Panel Hole Spacing

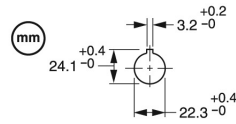

	40	50	40	50	40/60	50/60		60/90	70	50	40
	30		48		40/60				30	50	50

H7
D7 Pilot Devices

Non-illuminated and Illuminated Flush Push Button Operators (D7x-F)

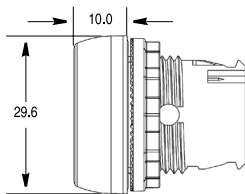

Illuminated and Non-illuminated Extended Push Button Operators (D7x-LE & D7x-E)

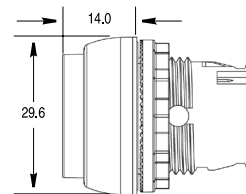

Non-illuminated Guarded and Non-illuminated Maintained Push Button Operators (D7x-G and D7x-FA)

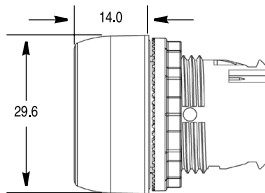

Illuminated Guarded Push Button Operators (D7x-LG)

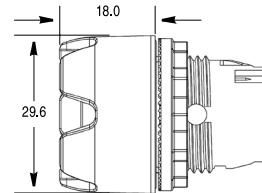

Reset Operators (D7x-R)

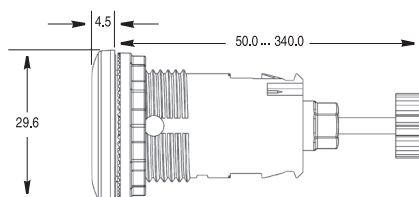

Pilot Light Operators (D7x-P)

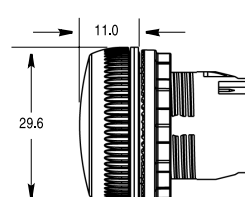

① Dimensions are not intended to be used for manufacturing purposes.

Approximate Dimensions – millimeters ❶

Illuminated and Non-illuminated Momentary Mushroom Operators 40mm and 60mm (D7x-LMM & D7x-MM)

Operator	A
40mm	39.8
60mm	59.8

Illuminated and Non-illuminated 3-Position Mushroom Operators 40mm (D7M-MM4/MP4_E3 & D7M-LMM4/LMP4_E3)

Dimension B Position	
Out	37.9
Center	35.3
In	32.9

Illuminated and Non-illuminated Selector Switch Operators (D7x-LS, D7x-S & D7x-H Long)

Non-illuminated 3-Position Multi-Function Operators (D7x-U3)

Illuminated and Non-illuminated Push-Pull Mushroom Operators 30mm, 40mm, and 60mm (D7x-MP)

Operator	A
30mm	30
40mm	40
60mm	60

Illuminated and Non-illuminated Twist-to-Release Operators 30mm, 40mm, and 60mm (D7x-MT)

Operator	A
30mm	30
40mm	40
60mm	60

Illuminated and Non-illuminated 2-Position Multi-Function Operators (D7x-LU2 & D7x-U2)

Mushroom Key Release Operator 40mm (D7x-MK)

Key Selector Switch Operators (D7x-K)

Back-of-Panel Components – Incandescent Module with Latch (D7-DOC & D7-ALP/M)

Back-of-Panel Components – Contact Cartridges with Latch (D7-X/Q + D7-ALP/M)

30 x 40mm Snap-in-Legend Plate (D7-11)

Back-of-Panel Components – LED Module with Latch (D7-N/Q & D7-ALP/M)

Back-of-Panel Components – (Max. of 1 Deep) (D7-X01S)

30 x 50mm Snap-in-Legend Plate (D7-12)

❶ Dimensions are not intended to be used for manufacturing purposes.

Approximate Dimensions – millimeters ①②

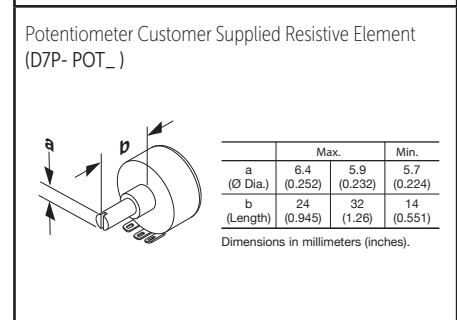
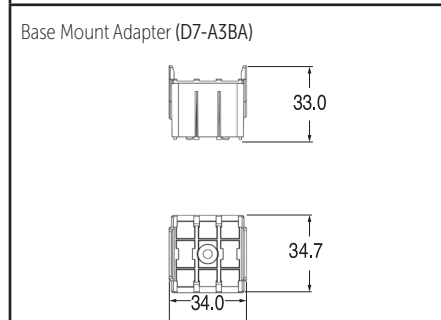
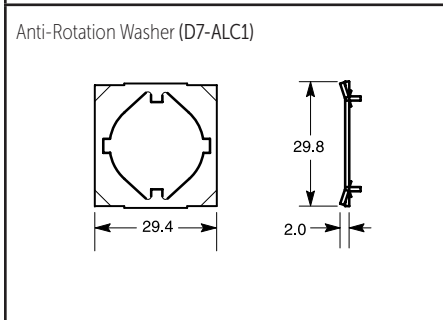
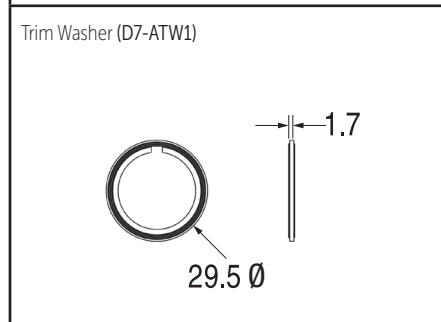
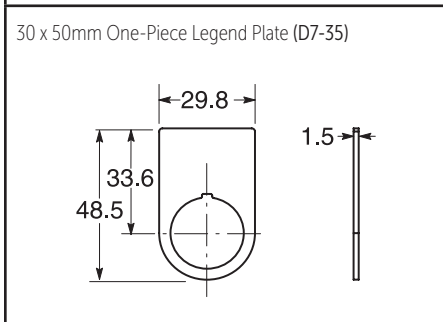
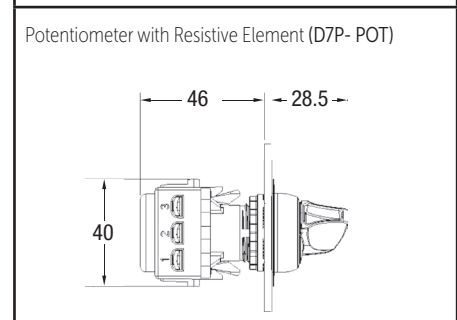
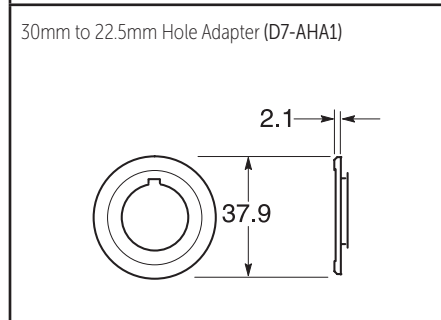
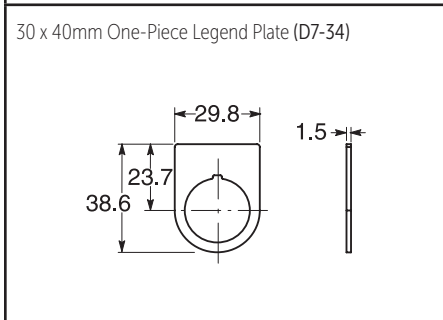
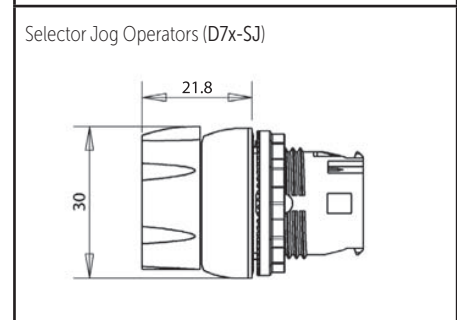
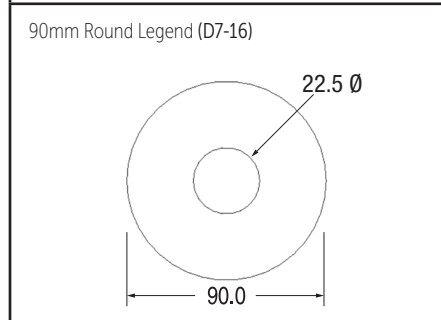
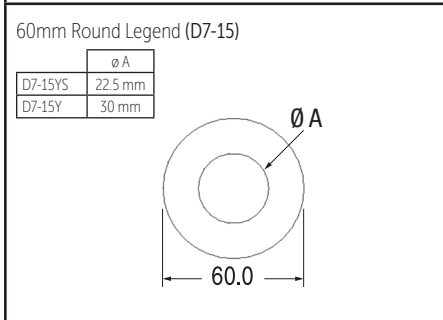
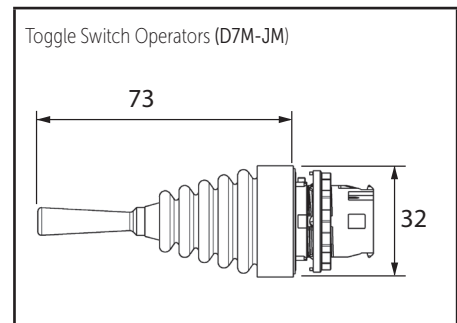
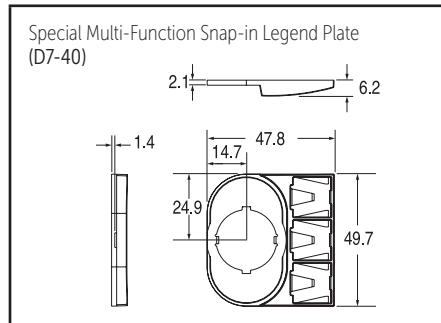
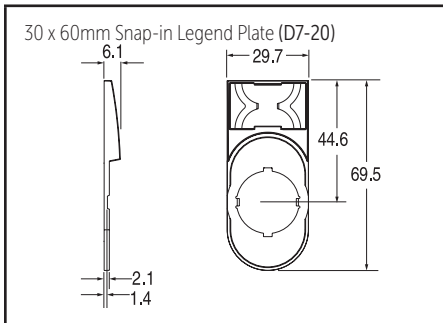

① Dimensions are not intended to be used for manufacturing purposes.
 ② Panel thickness range is 1.0...6.0 maximum. Panel thickness reduced to 4.5 when optional legend plates are used.

Approximate Dimensions – millimeters ❶

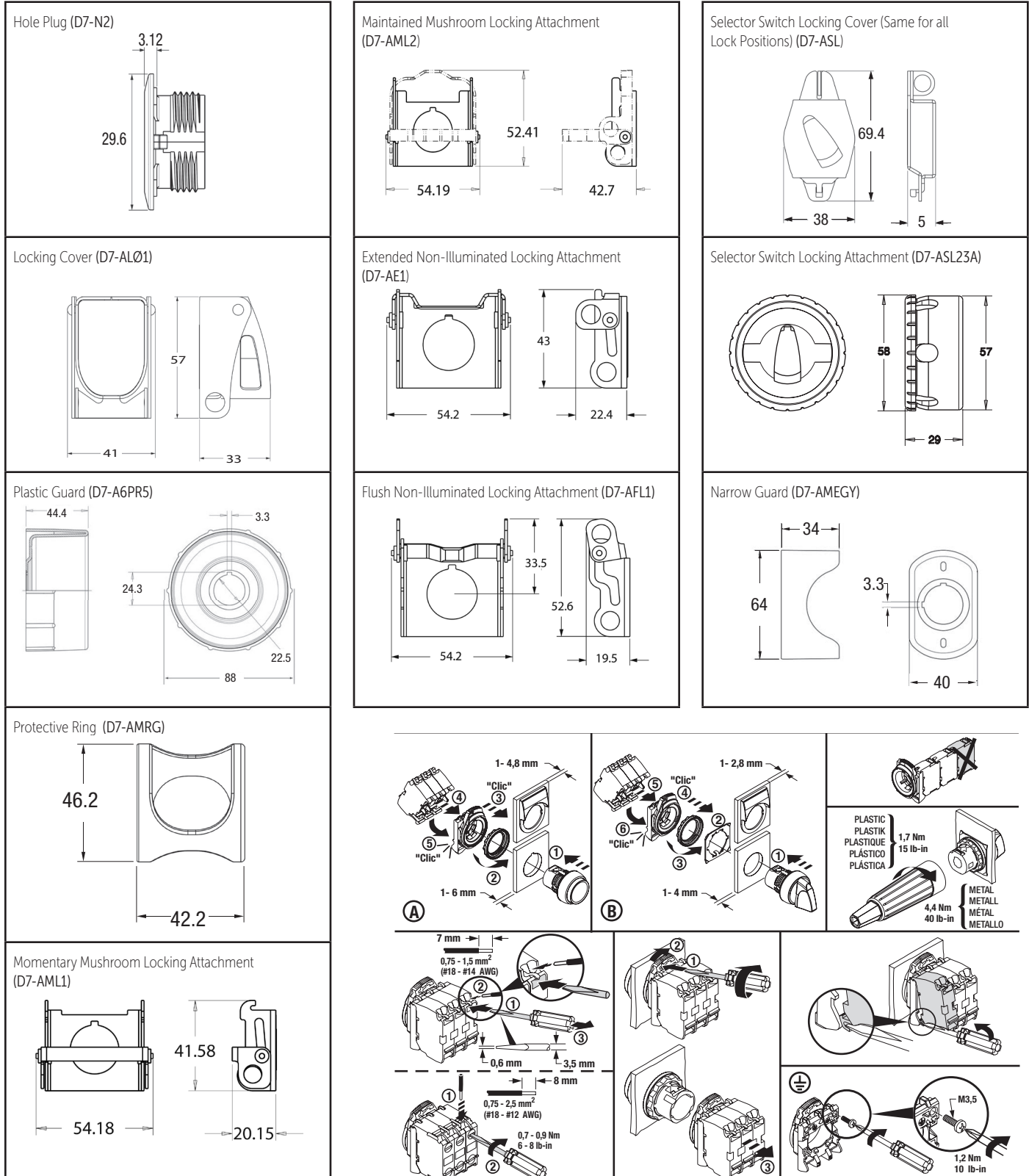

H7
 D7 Pilot Devices

❶ Dimensions are not intended to be used for manufacturing purposes.

Approximate Dimensions – millimeters ①

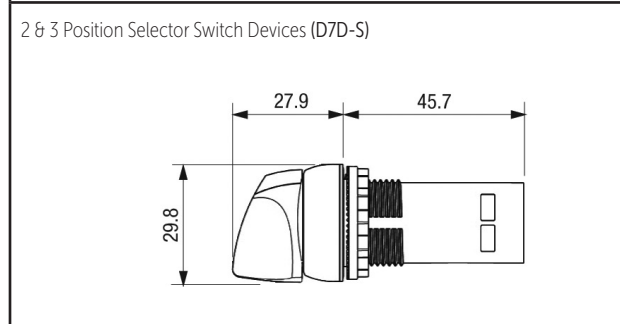
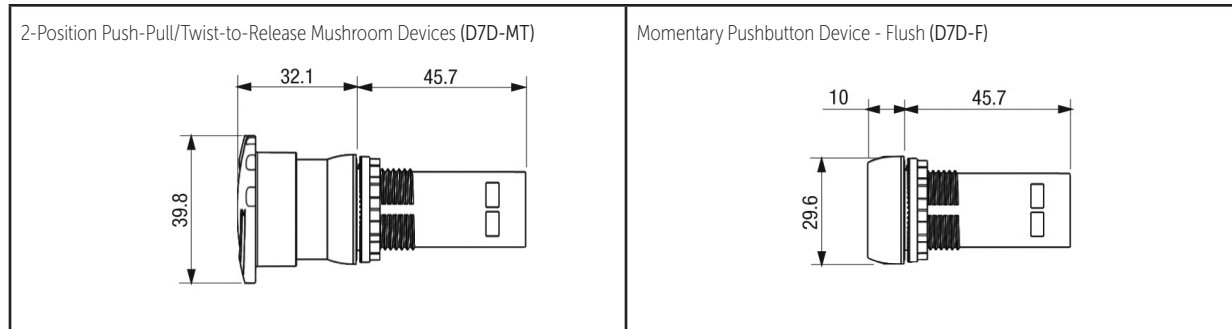

PANEL HOLE SPACING

(A)							ø60, ø90
(A)							
(B)							
	30	40	50	40	50		
		30		40			60 / 90

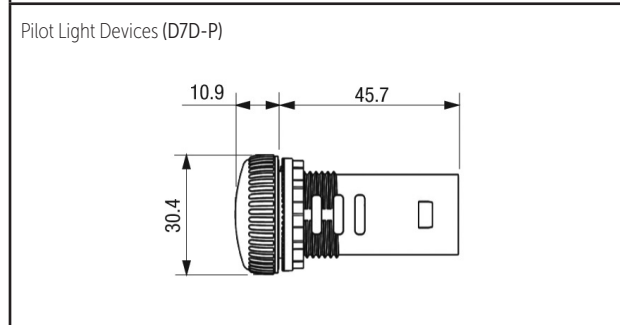
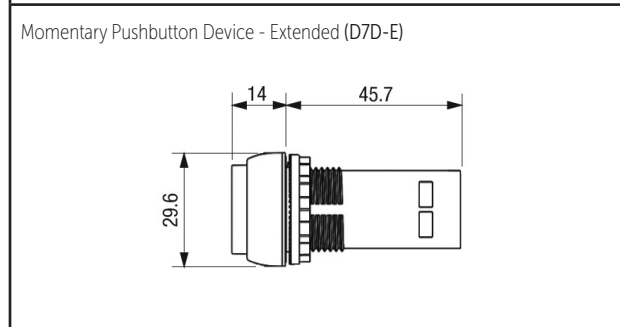

(A)

(B)

PLASTIC 1.7 Nm
15 lb-in

① 0.7 - 0.9 Nm
6 - 8 lb-in

②

③

Use the same size wire only

0.75 - 1.5 mm²
(#18 - #14 AWG)

or
ou
oder
o

④

"R" option for ring connectors

ø 3.8 mm
ø 6.35 mm

50 mm

① Dimensions are not intended to be used for manufacturing purposes.

Approximate Dimensions – millimeters ❶

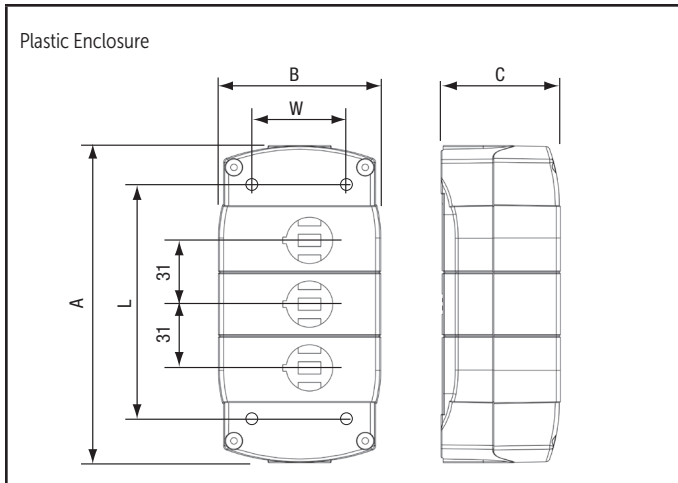

Type - 4/4X/13 (IP66) - Plastic Enclosures ❷

Cat. No.	No. of Units (Holes)	Length A	Width B	Depth C	Mtg. Holes		Knockout/Conduit Openings
					W	L	
D7-1PP (1YP)	1	85 (3-11/32)	89 (3-1/2)	58 (2-9/32)	58	59	PG11 PG16
D7-2PP	2	124 (4-7/8)	79 (3-1/8)	58 (2-9/32)	48	102.5	PG11 PG16
D7-3PP	3	155 (6-3/32)	79 (3-1/8)	58 (2-9/32)	48	133	PG11 PG16
D7-4PP	4	186 (7-5/16)	79 (3-1/8)	58 (2-9/32)	48	164.5	PG11 PG16
D7-6PP	6	248 (9-3/4)	87 (3-7/16)	64 (2-17/32)	55	224	PG16

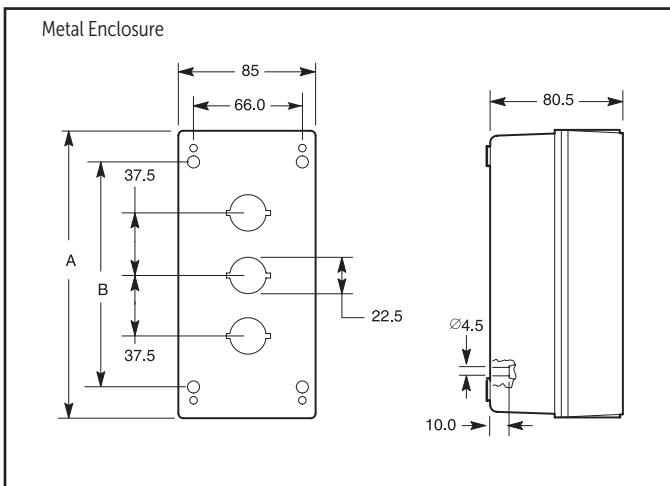

Type 4/13 (IP66) - Metal Enclosures

Cat. No.	No. of Units (Holes)	Length A	Mtg. Holes B	Knockout/Conduit Openings
D7-1MP (1MY)	1	99 (3-9/10)	62 (2-7/16)	PG11 PG16
D7-2MP	2	137 (5-13/32)	100 (3-15/16)	PG11 PG16
D7-3MP	3	174 (6-27/32)	137 (5-13/32)	PG11 PG16
D7-5MP	5	249 (9-13/32)	212 (8-11/32)	PG16

H7
D7 Pilot Devices

❶ Dimensions are not intended to be used for manufacturing purposes.
 ❷ Mounting screw head diameter = 7mm max. for 1P enclosures

Approximate Dimensions – millimeters ①

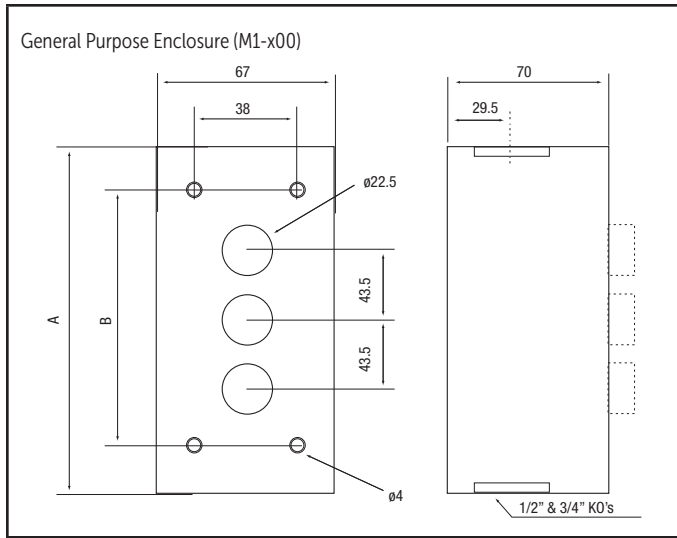

Type 1 - Metal Enclosures			
Cat. No.	No. of Units (Holes)	A	B
M1-100	1	114 (4-1/2)	51 (2)
M1-200	2	114 (4-7/8)	51 (2)
M1-300	3	157 (6-1/4)	102 (4)

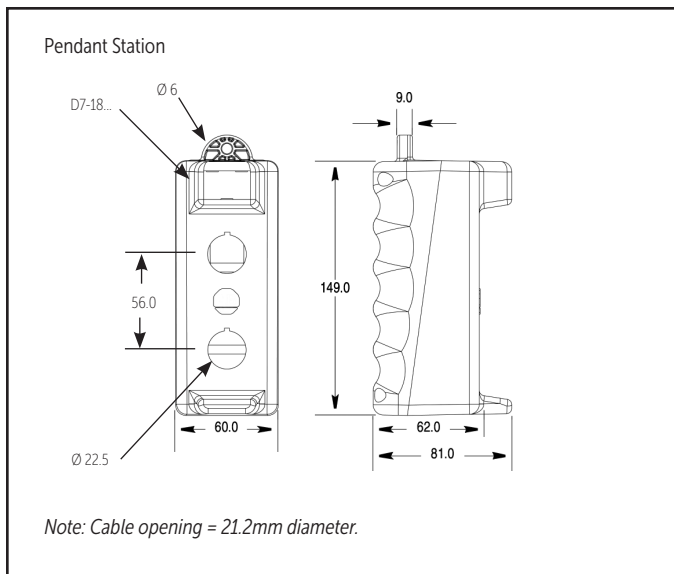

H7
D7 Pilot Devices

① Dimensions are not intended to be used for manufacturing purposes.